



شركة الخدمات البحرية المحدودة
MARINE SERVICES CO., LTD.



Surgical Forceps Instruments

Precision • Quality • Reliability

Tissue & Dissecting Forceps

1. Intestinal & Tissue Grasping Forceps
2. Ultra-Light Dissecting Forceps

Gastrointestinal Forceps

1. Gastro-Intestinal Forceps (Twin)
2. Stomach Clamps
3. Intestinal Clamps, Soft elastic
4. Intestinal Clamps
5. Intestinal & Pylorus Clamps
6. Sigmoid Anastomosis Forceps

Rectal & Anal Instruments

1. Rectal Specula
2. Anoscopes / Sphincteroscopes

Specialized Forceps

1. Biopsy Forceps
2. Swab Holders
3. Haemorrhoidal Forceps
4. Gall Duct Forceps
5. Choledochus Forceps

Probes

1. Gall Duct Probes
2. Gall Duct Dilators & Gall Stone Scoops

Obstetric Forceps

1. Placenta Forceps
2. Ovum Forceps

ISO 13485 AND CE

Manufactured & supplied in compliance with international medical standards.

Intestinal and Tissue Grasping Forceps



MES-09-101
CHAPUT
 2 X 3 teeth, sharp
 125 mm.



MES- 09-102
TUFFIER
 5 x 6 teeth, sharp
 125 mm.



MES- 09-103
BOYS-ALLIS
 5 X 6 teeth, sharp
 155 mm.



MES-09-104
ALLIS
 4 X 5 teeth
 155 mm.



MES- 09-105
ALLIS
 155 mm.
 4 X 5 teeth



MES-09-106
ALLIS
 190 mm.
MES- 09-107
 255mm.
 5X6 teeth



MES- 09-108
JUDD-ALLIS
 3 X 4 teeth
 195 mm.

[Back to index](#)

Intestinal Grasping Forceps

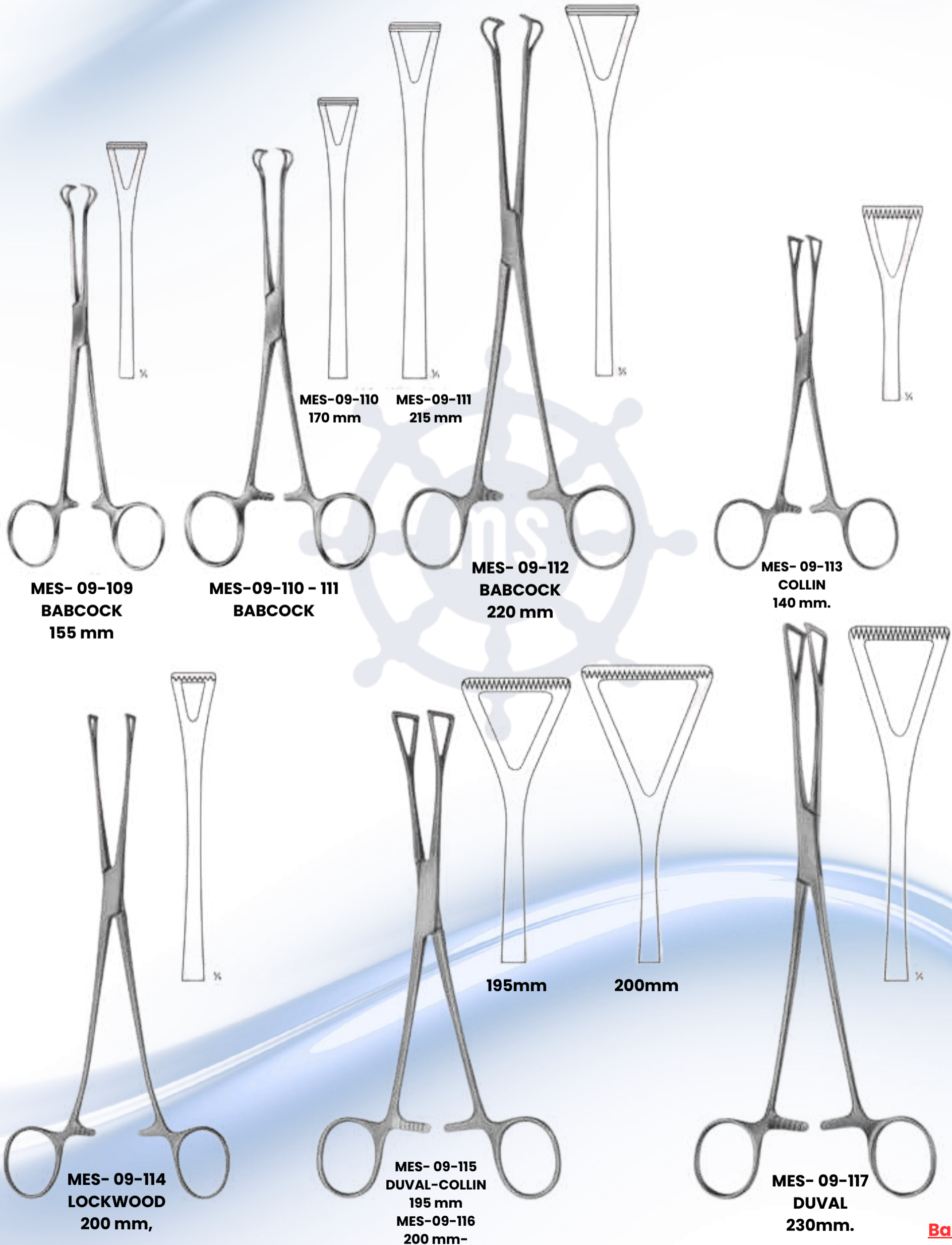

[Back to index](#)

Organ - Tissue Grasping, Dissecting & Intestinal Forceps



MES-09-118-120
LANE

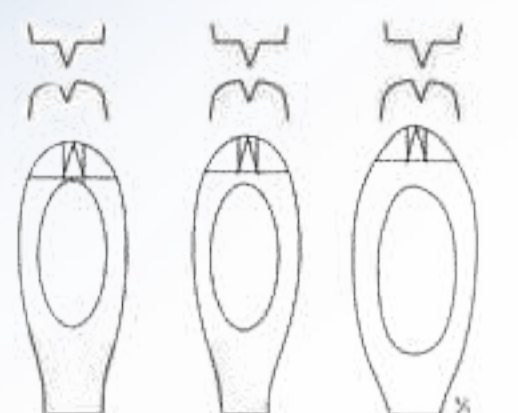

MES- 09-118
130 mm **MES- 09-118**
155 mm **MES- 09-118**
195 mm

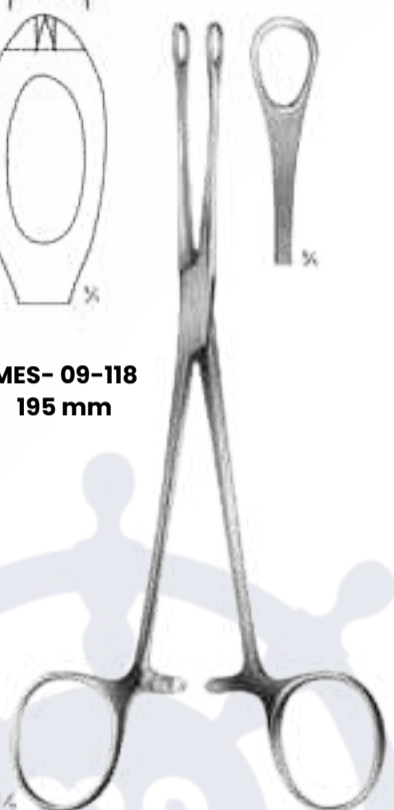

MES-09-121
WILLIAMS
160 mm



MES-09-122
DENIS BROWNE
190 mm



MES-09-123
DUVAL
140 mm



MES- 09-124
WANGENSTEEN
150 mm
09-125
230 mm



09-124 09-125
DUROGRIP



MES-09-126
WANGENSTEEN
150 mm
09-127
230 mm

[Back to index](#)

Organ - Tissue Grasping, Dissecting & Intestinal Forceps

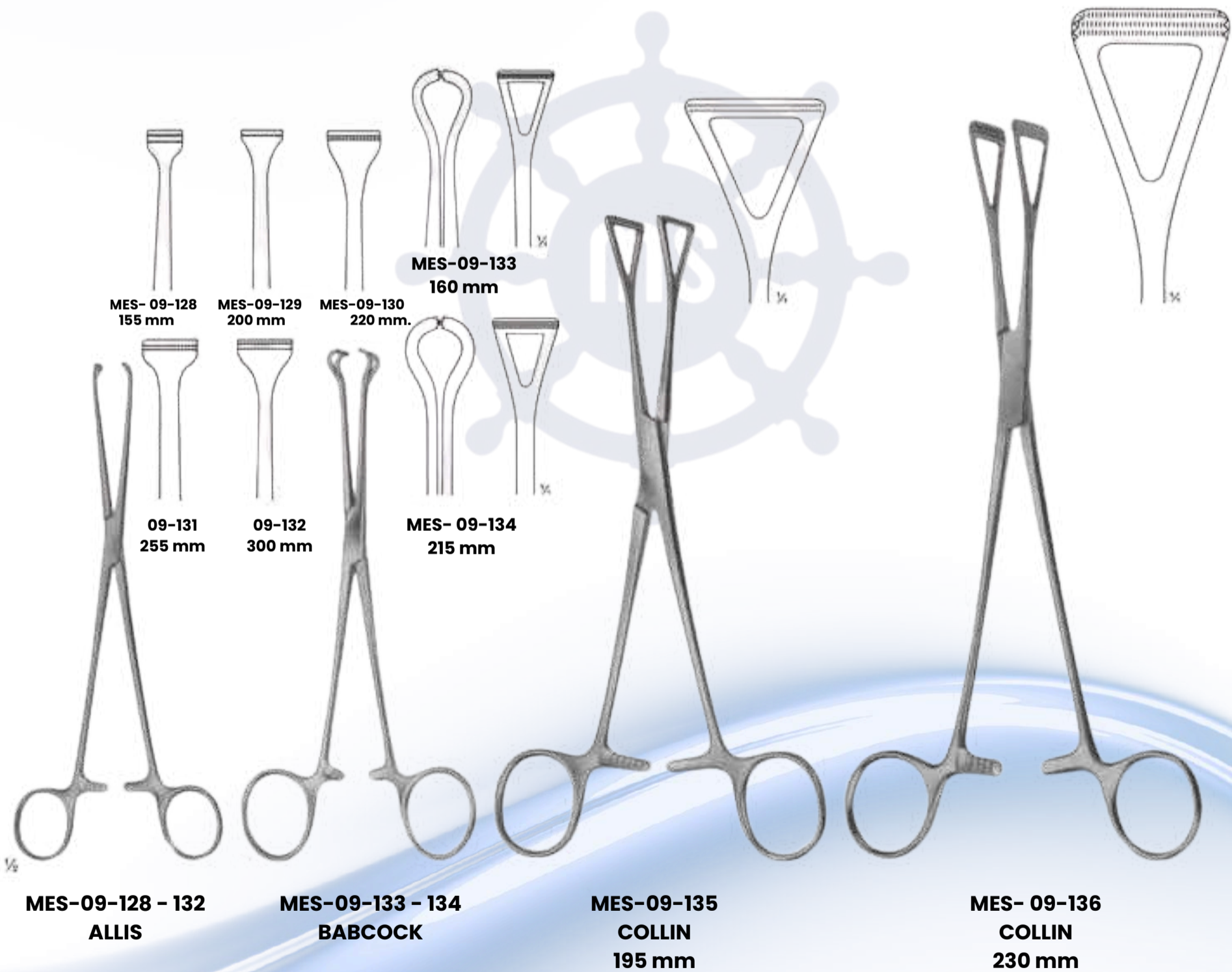

Ultra - Light - Forceps, Dissecting Forceps

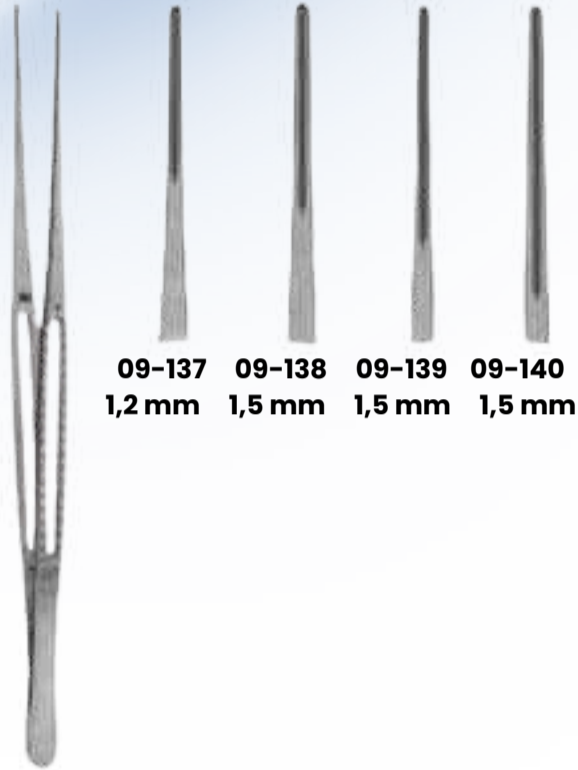

09-137 1,2 mm
09-138 1,5 mm
09-139 1,5 mm
09-140 1,5 mm

MES-09-137 150 mm
MES-09-138 200 mm
MES-09-139 240 mm
MES-09-140 300 mm

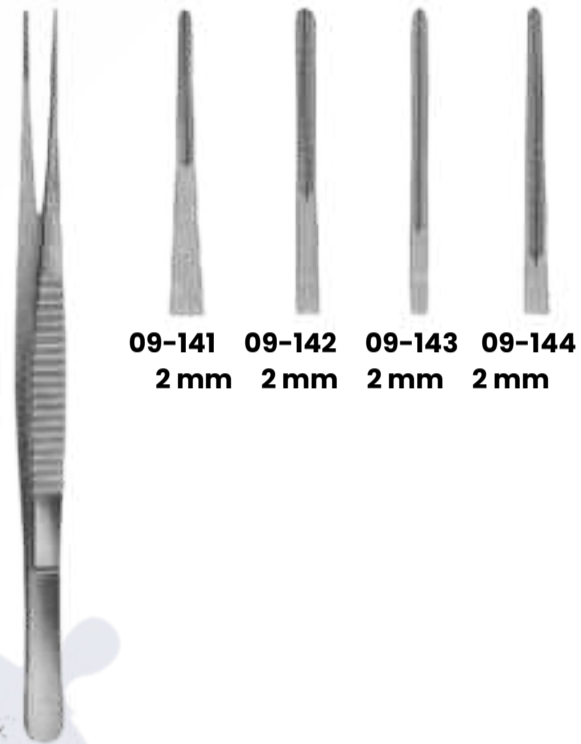

09-141 2 mm
09-142 2 mm
09-143 2 mm
09-144 2 mm

DE BAKEY
MES- 09-141 150 mm
MES- 09-142 200 mm
MES- 09-143 240 mm
MES-09-144 300 mm

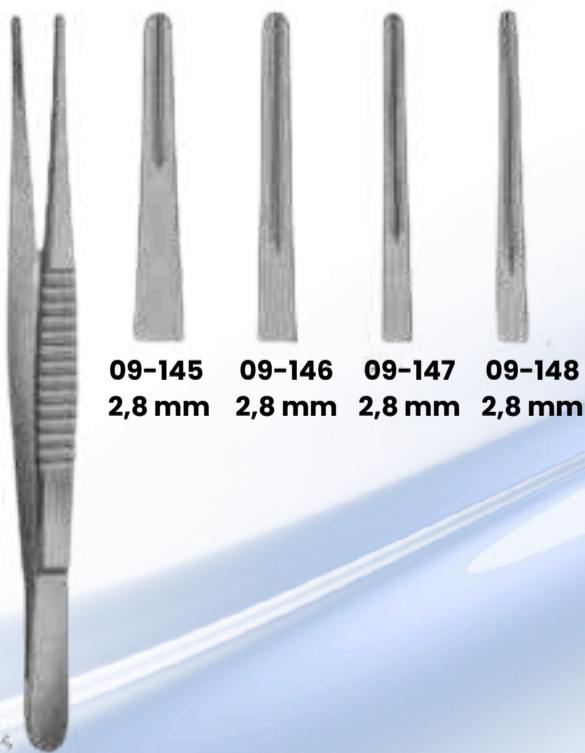

09-145 2,8 mm
09-146 2,8 mm
09-147 2,8 mm
09-148 2,8 mm

DE BAKEY
MES-09-145 150 mm
MES-09-146 200 mm
MES-09-147 240 mm
MES-09-148 300 mm

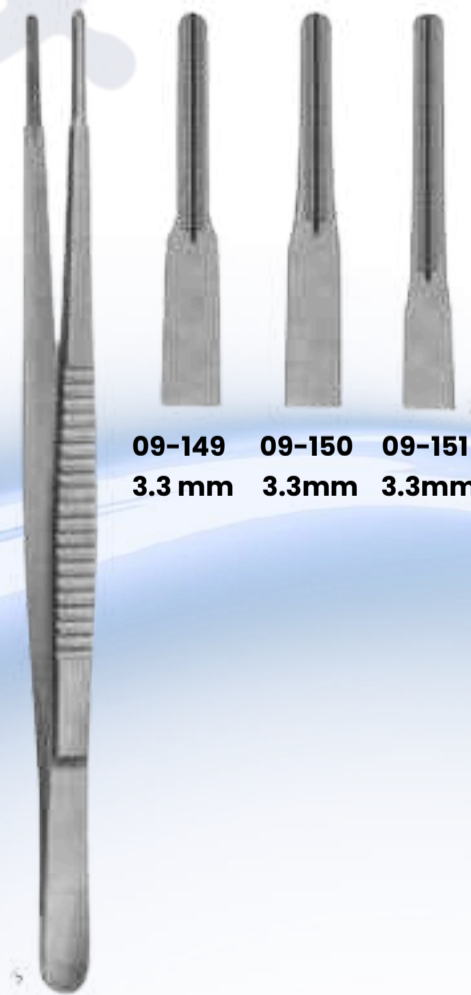

09-149 3.3 mm
09-150 3.3mm
09-151 3.3mm

DE BAKEY
MES- 09-149 200 mm
MES-09-150 240 mm
MES-09-151 300 mm

[Back to index](#)

Gastro-Intestinal Forceps, twin



MES-09-196
LANE
300 mm

MES-09-197
LANE
300 mm

[Back to index](#)

Stomach Clamps



MES-09-198



MES-09-199



MES-09-198 - 199
SCUDDER
330 mm



MES- 09-200
KLEINSCHMIDT
Spur crushers and
Appendectomy clamps
130 mm

Intestinal Clamps, Soft Elastic

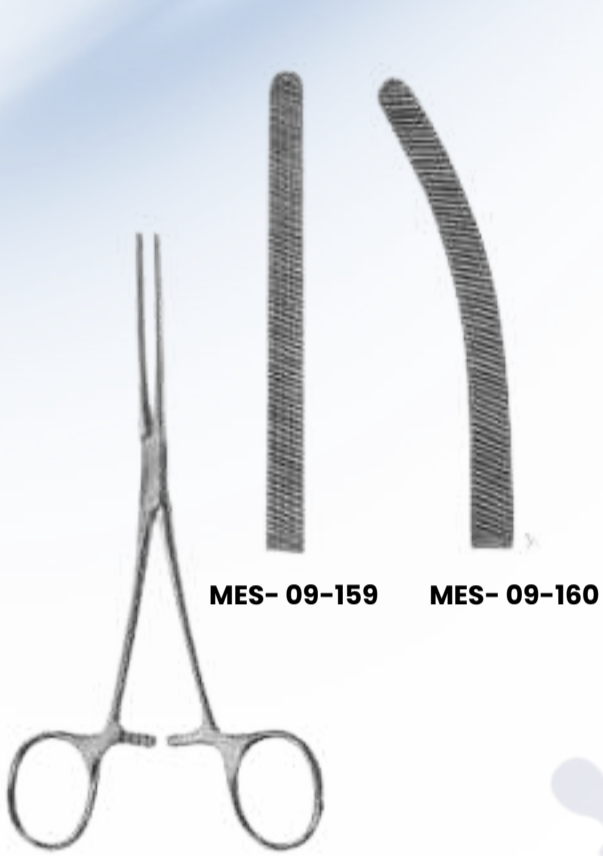

MES- 09-159 - 160
DOYEN elastic
165 mm

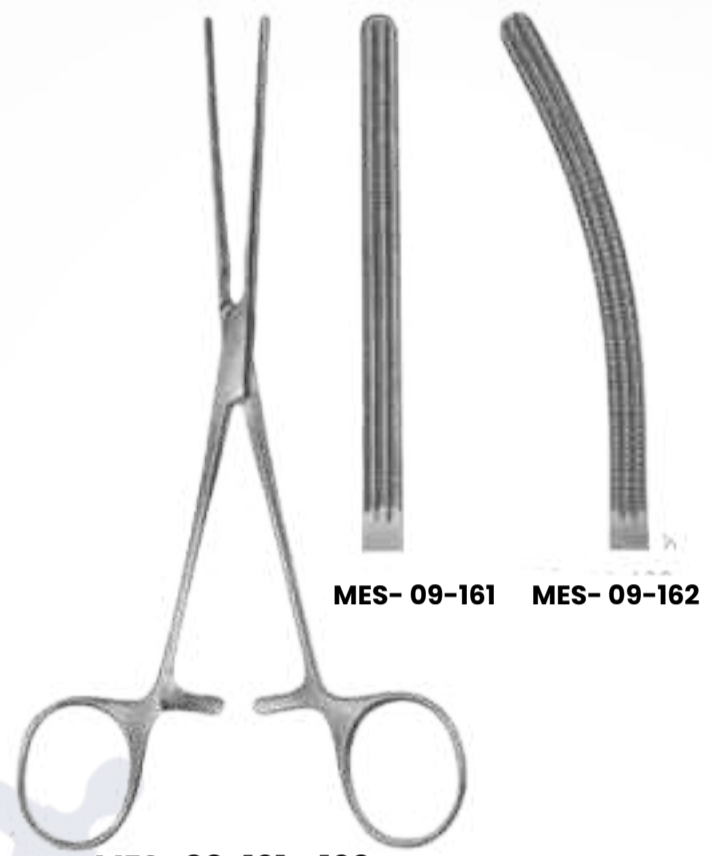

MES- 09-161 - 162
DOYEN
with elastic blades
170 mm



MES- 09-163 - 164
HARTMANN
with elastic blades
200mm



MES- 09-165 - 166
HARTMANN
with elastic blades
200 mm

[Back to index](#)

Intestinal Clamps, Soft elastic

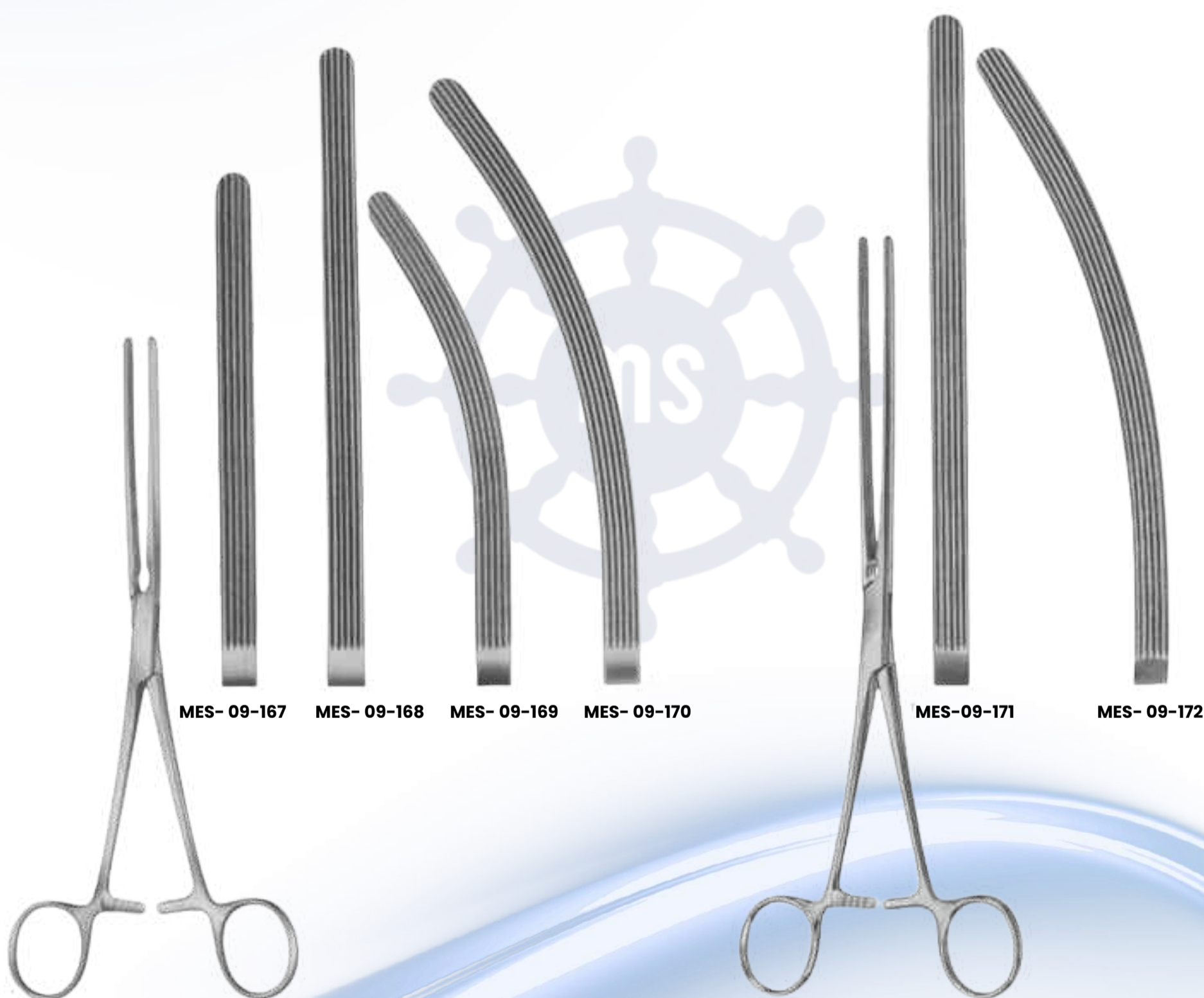

MES• 09-167 - 170
KOCHER
with elastic blades
 MES-09-169 210 mm
 MES-09-170 230 mm

MES- 09-171 - 172
DOYEN
with elastic blades
 210 mm

Intestinal Clamps, Soft elastic



MES- 09-173



MES- 09-174



MES- 09-175



MES- 09-176

MES- 3-173 - 174
DOYEN
 with elastic blades
 235 mm

MES-09-175 - 176
DOYEN
 with elastic blades
 230 mm

Intestinal Clamps, Soft elastic

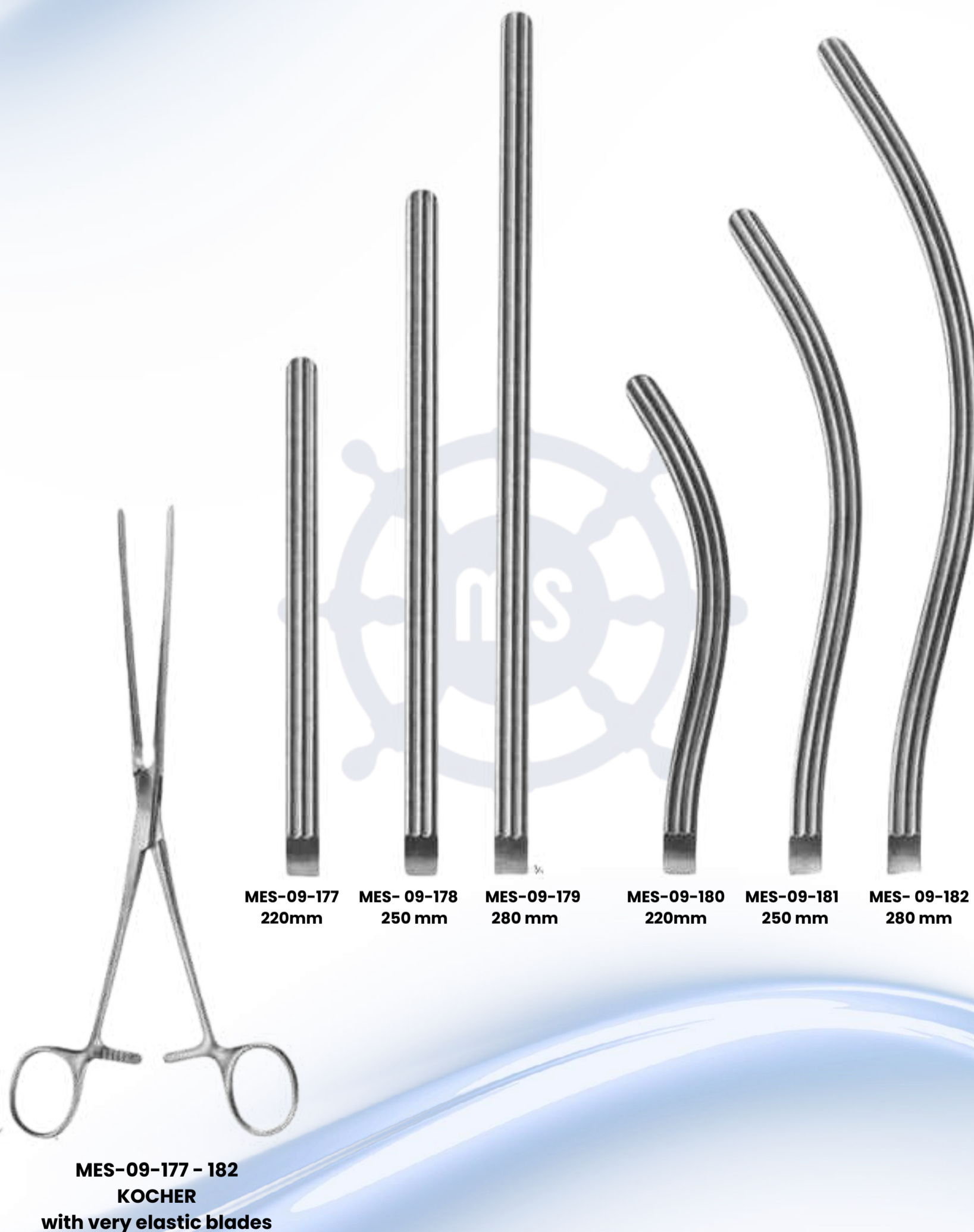

Intestinal Clamps, Soft elastic

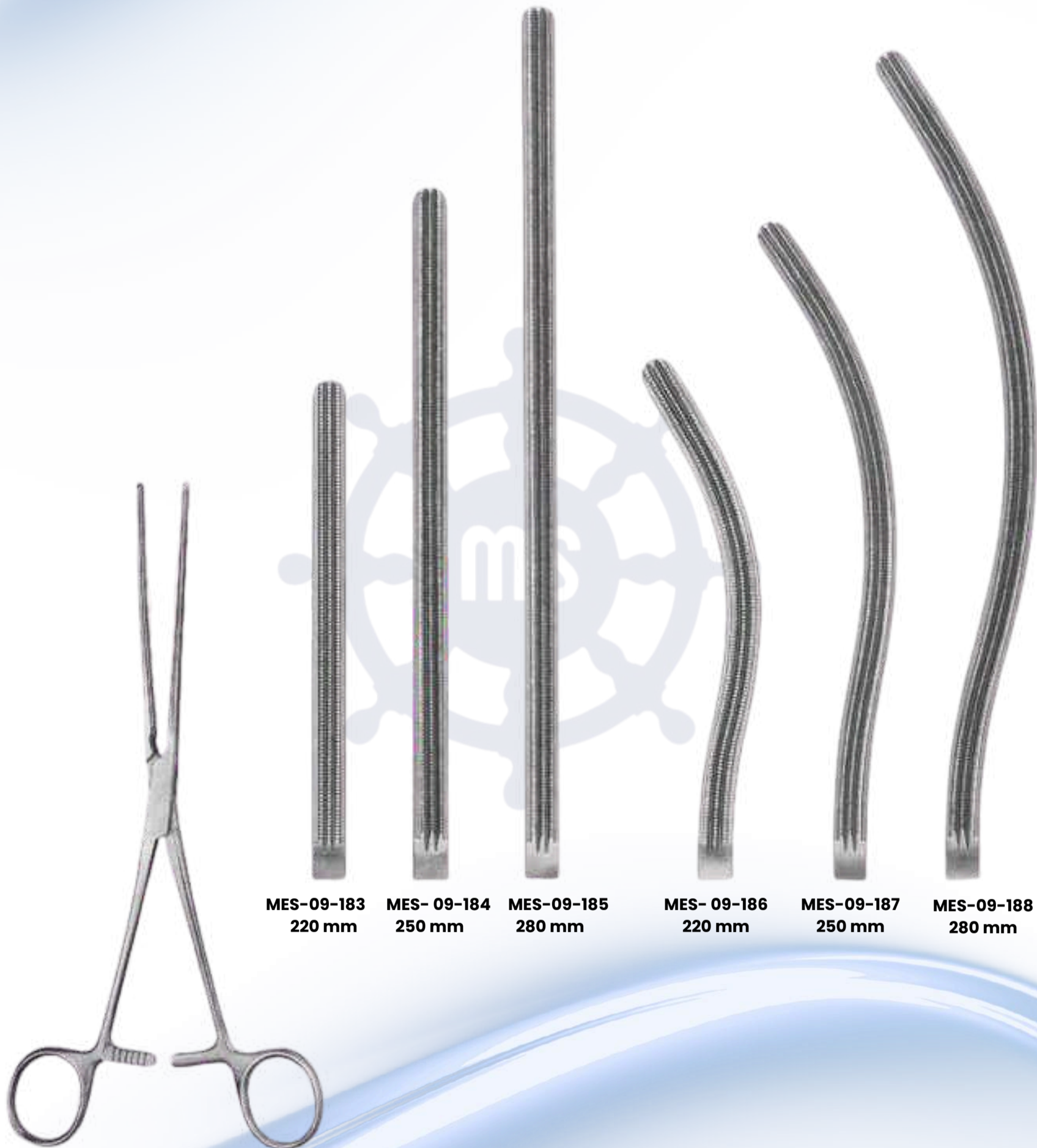

MES-09-183
220 mm

MES-09-184
250 mm

MES-09-185
280 mm

MES-09-186
220 mm

MES-09-187
250 mm

MES-09-188
280 mm

MES-09-183 - 188
KOCHER
with very elastic blades

Intestinal Clamps



MES-09-189



MES- 09-190



MES- 09-191

MES- 09-189 - 190
NUSSBAUM
with elastic blades
250 mm

MES-09-191
MOYNIHAN
280 mm

Intestinal Clamps



MES- 09-192



MES- 09-193



MES- 09-194



MES- 09-195

MES-09-192 - 193
MAYO-ROBSON
hard elastic
250 mm

MES- 09-194 - 195
MAYO-ROBSON
250 mm

Intestinal and Pylorus Clamps



MES- 09-201
PAYR
 Intestinal clamp
 light pattern. for
 children
 180 mm

MES- 09-202
PAYR
 200 mm

MES- 09-203
PAYR
 275mm

MES- 09-204
PAYR
 Pylorus clamp
 315 mm

[Back to index](#)

Anastomosis Forceps

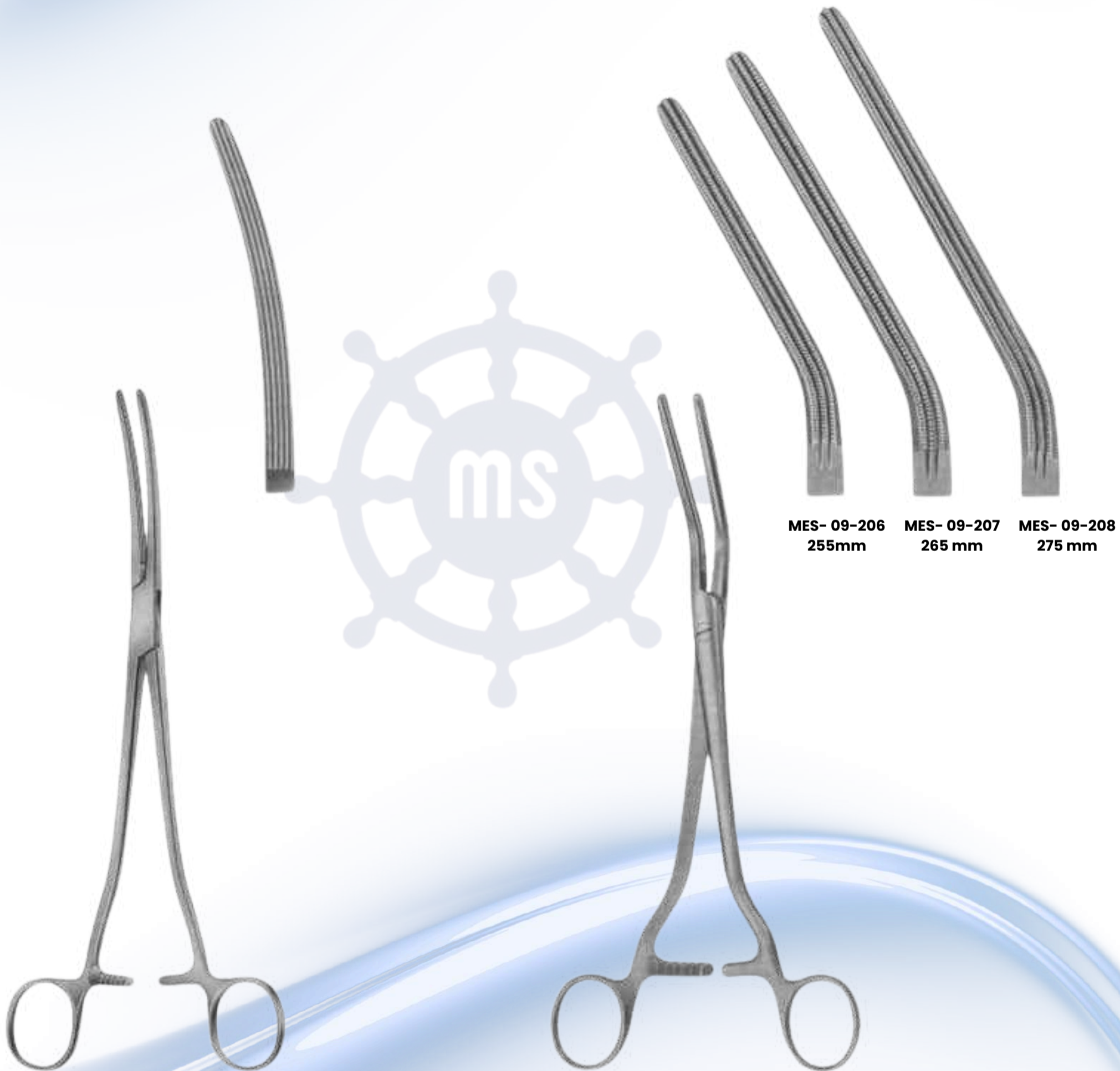

MES-09-205
PARKER-KERR
anastomosis forceps for
colon resection
180 mm

MES- 09-206 - 208
DICK
pressure clamps
180mm

MES- 09-206 **MES- 09-207** **MES- 09-208**
255mm **265 mm** **275 mm**

[Back to index](#)

Sigmoid Anastomosis Forceps



MES- 09-209

MES- 09-210

MES- 09-209
MES- 09-210
230 mm

MES- 09-211
LLOYD-DAVIS
315mm

Sigmoid Anastomosis Forceps

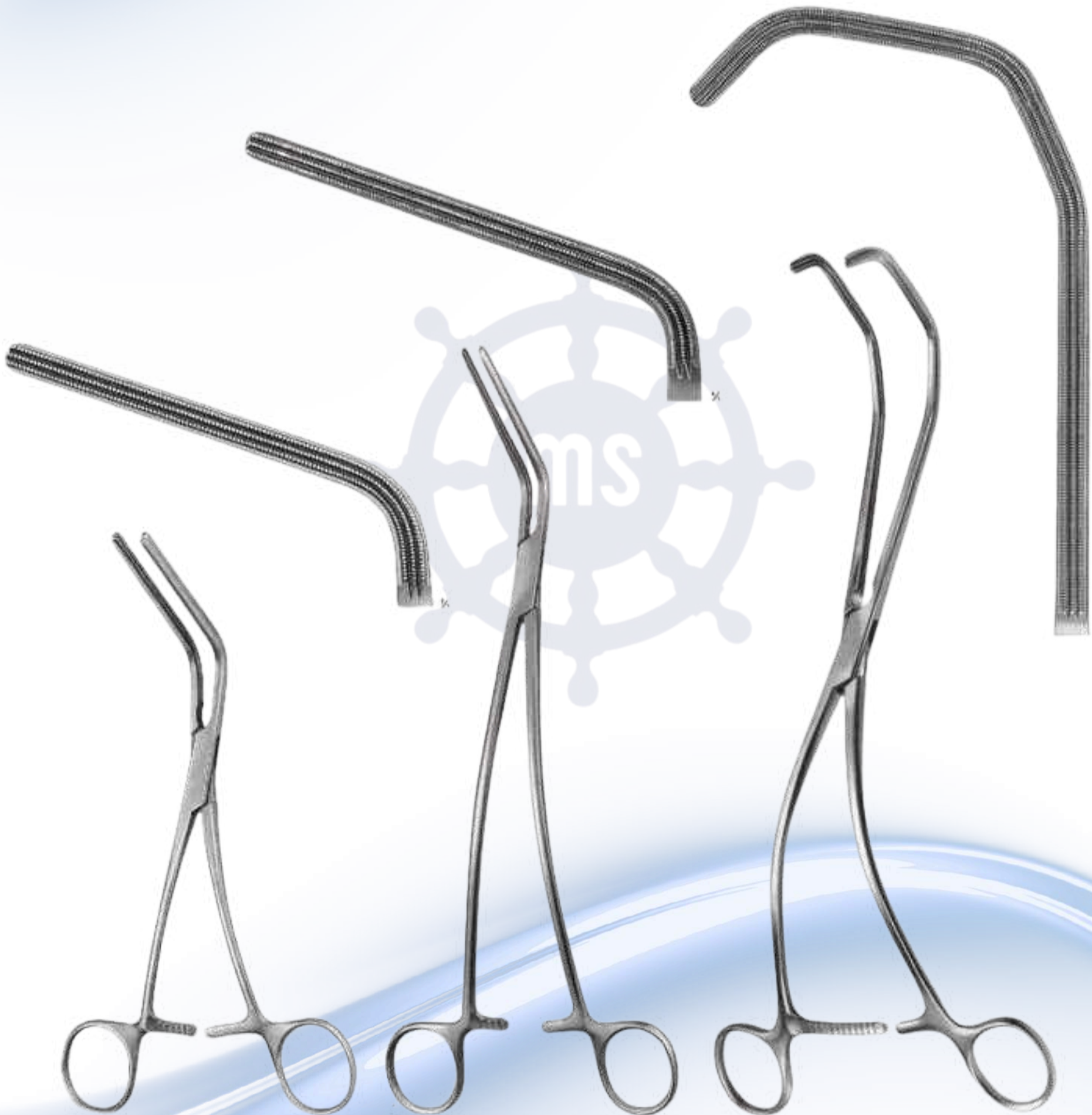

MES- 09-212
MORRIS
175 mm

MES- 09-213
DE BAKEY
(MORRIS modif.)
240 mm

MES- 09-214
KERSTING
270 mm

Rectal Specula



MES- 10-101
KILLIAN for children
145 mm



MES- 10-102
SIMS
160 mm



MES- 10-103
SIMS
160 mm

Rectal Specula



10-104 - 107



MES. 10-104
SIMS for children
190 mm

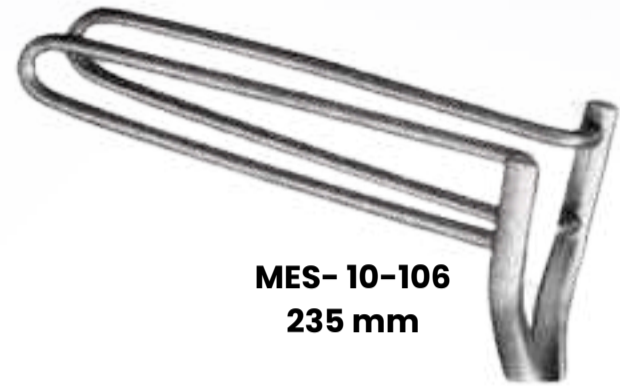

MES- 10-106
235 mm



MES- 10-105
SIMS for adults
235 mm



MES- 10-107
245 mm

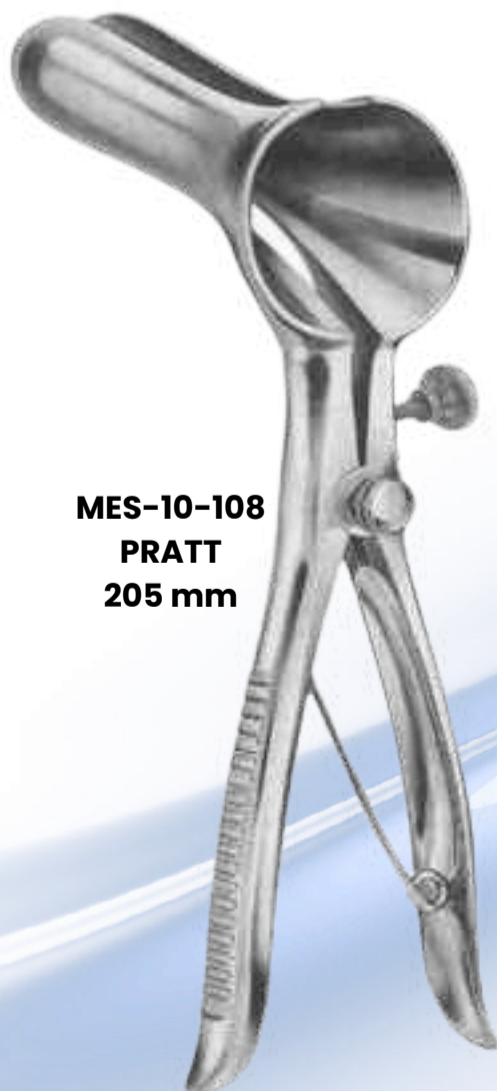

MES-10-108
PRATT
205 mm

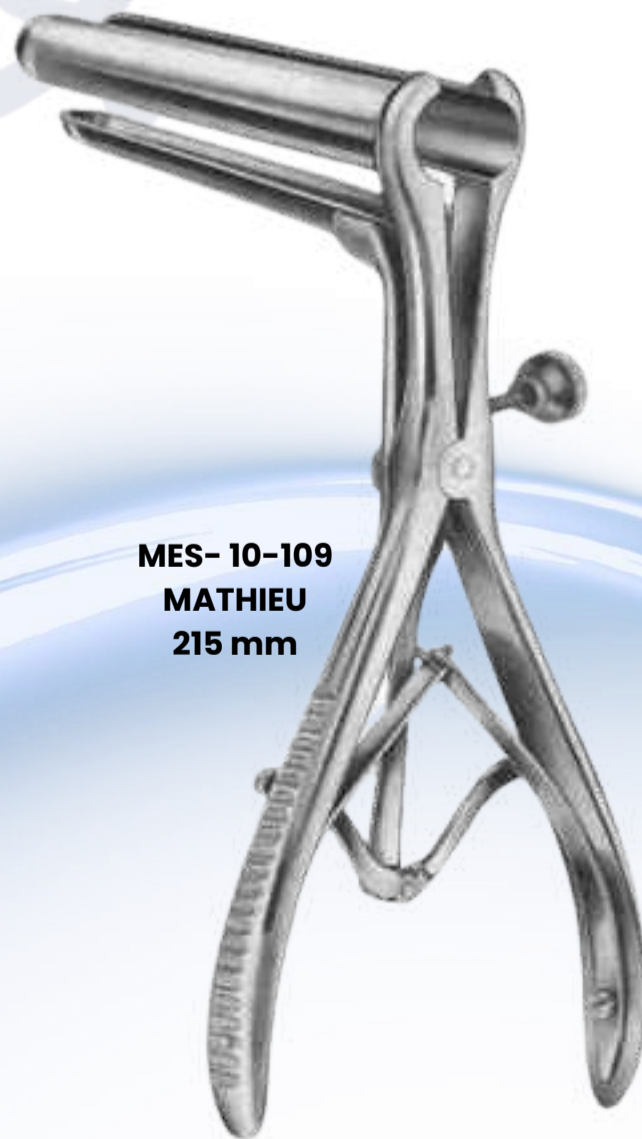

MES- 10-109
MATHIEU
215 mm

Anusscopes-Sphincteroscopes



**MES- 10-110
IVES-FANSLER
Anuscops
145 mm**



**MES- 10-111
KELLY
Sphincteroscope
160 mm**



**MES-10-112
KELLY
Sphincteroscope
160 mm**



**MES- 10-113
KELLY
Proctoscope
160 mm**

[Back to index](#)

Biopsy forceps for rectum

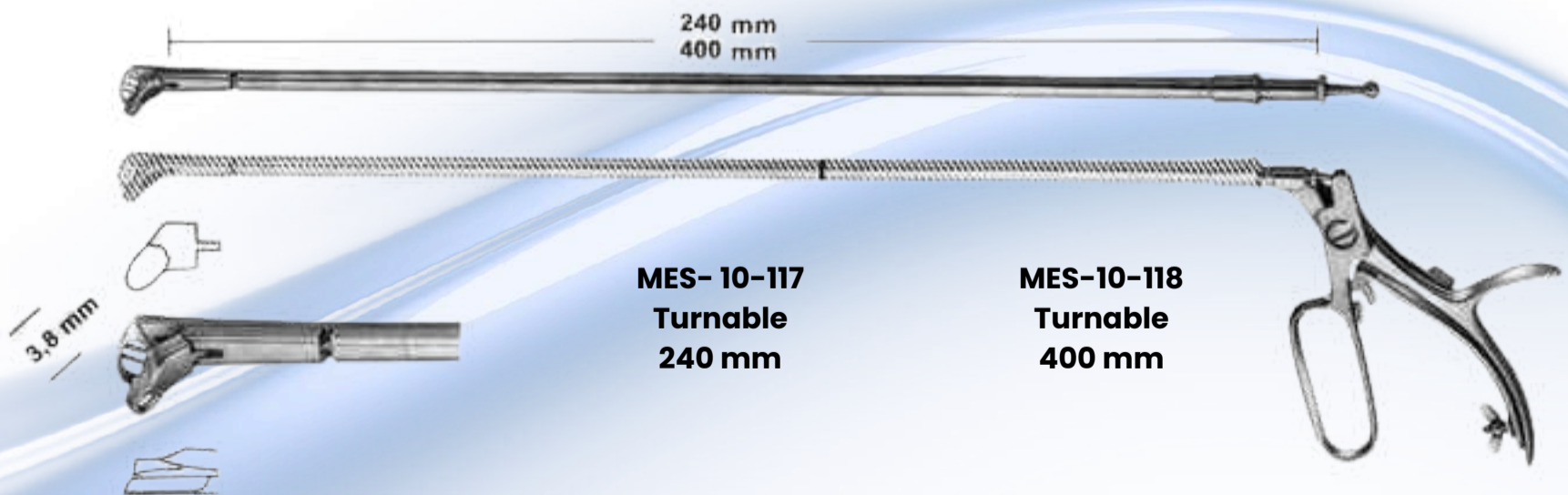
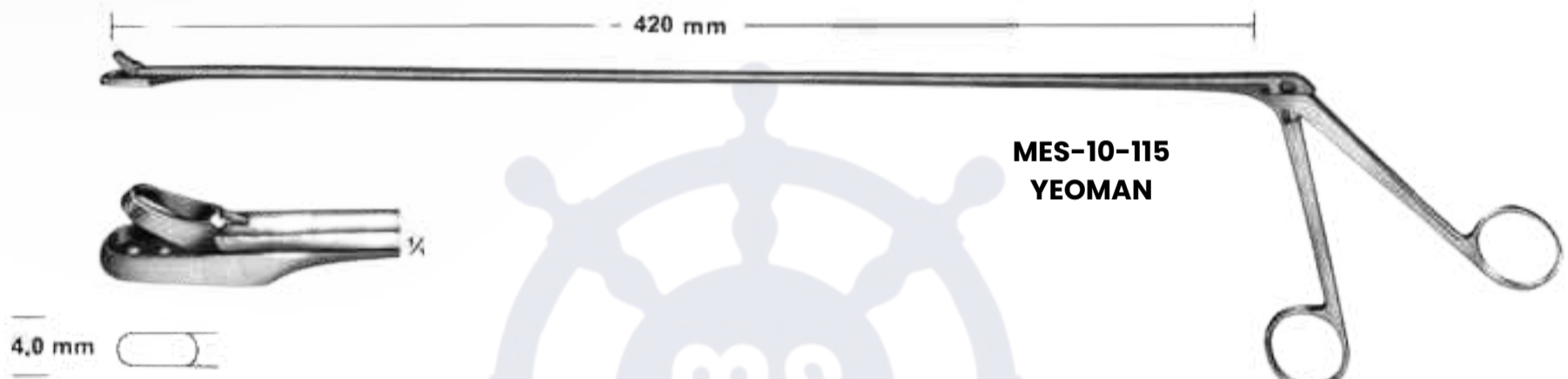
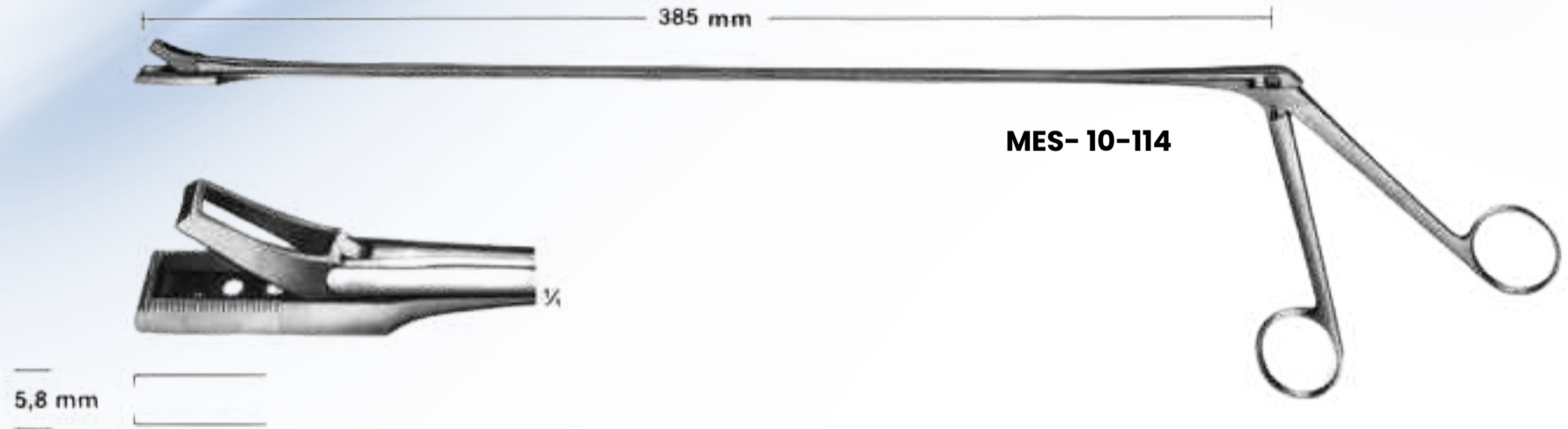

Biopsy Forceps & Swab Holders

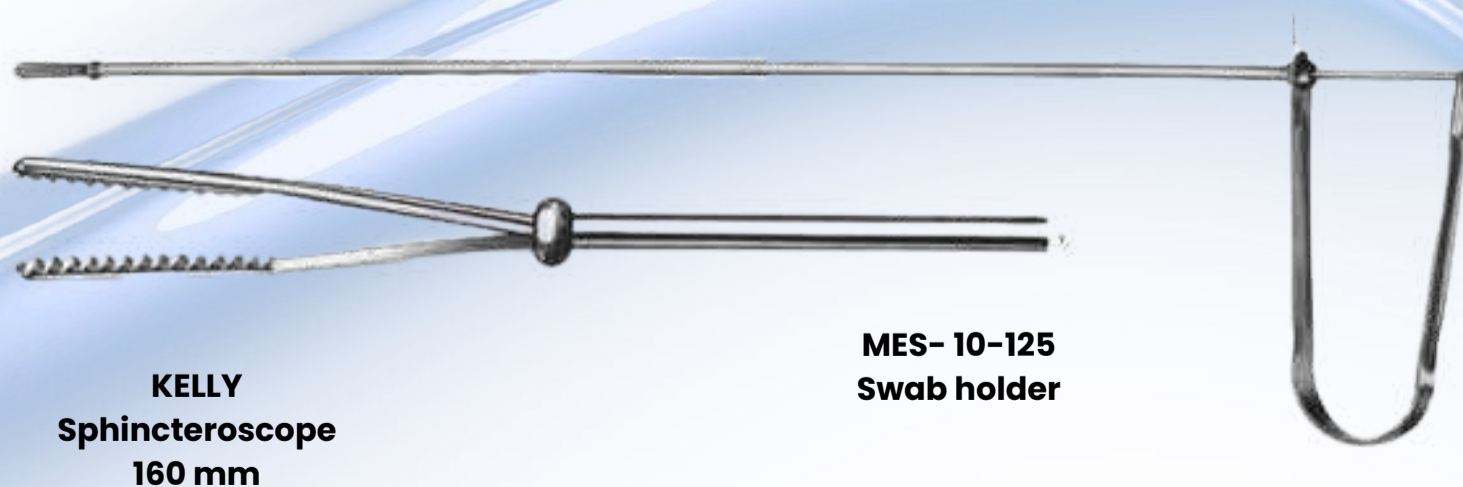
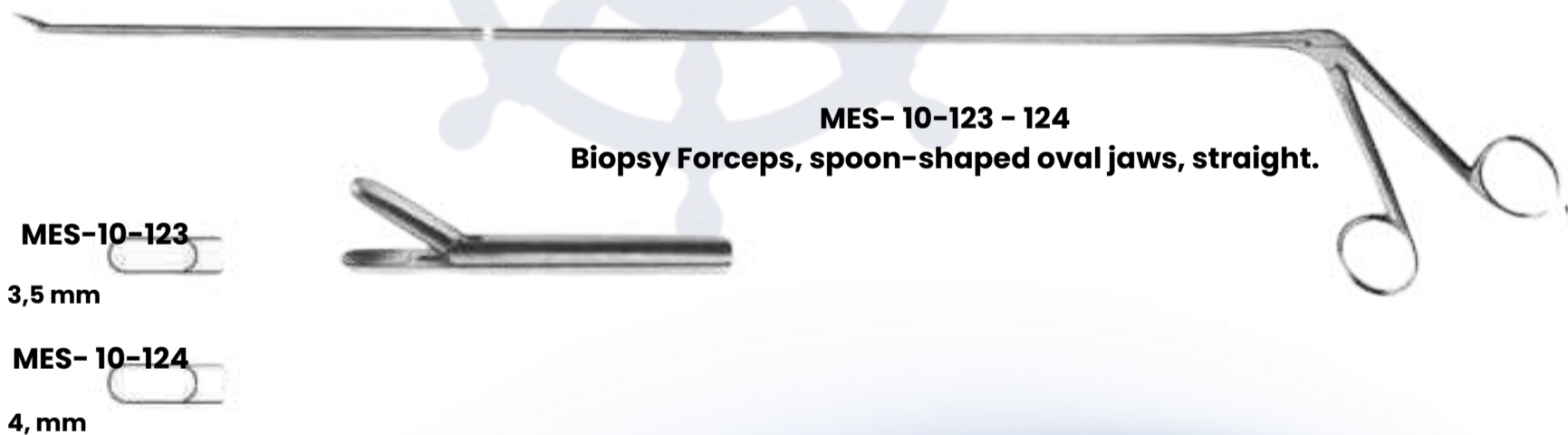
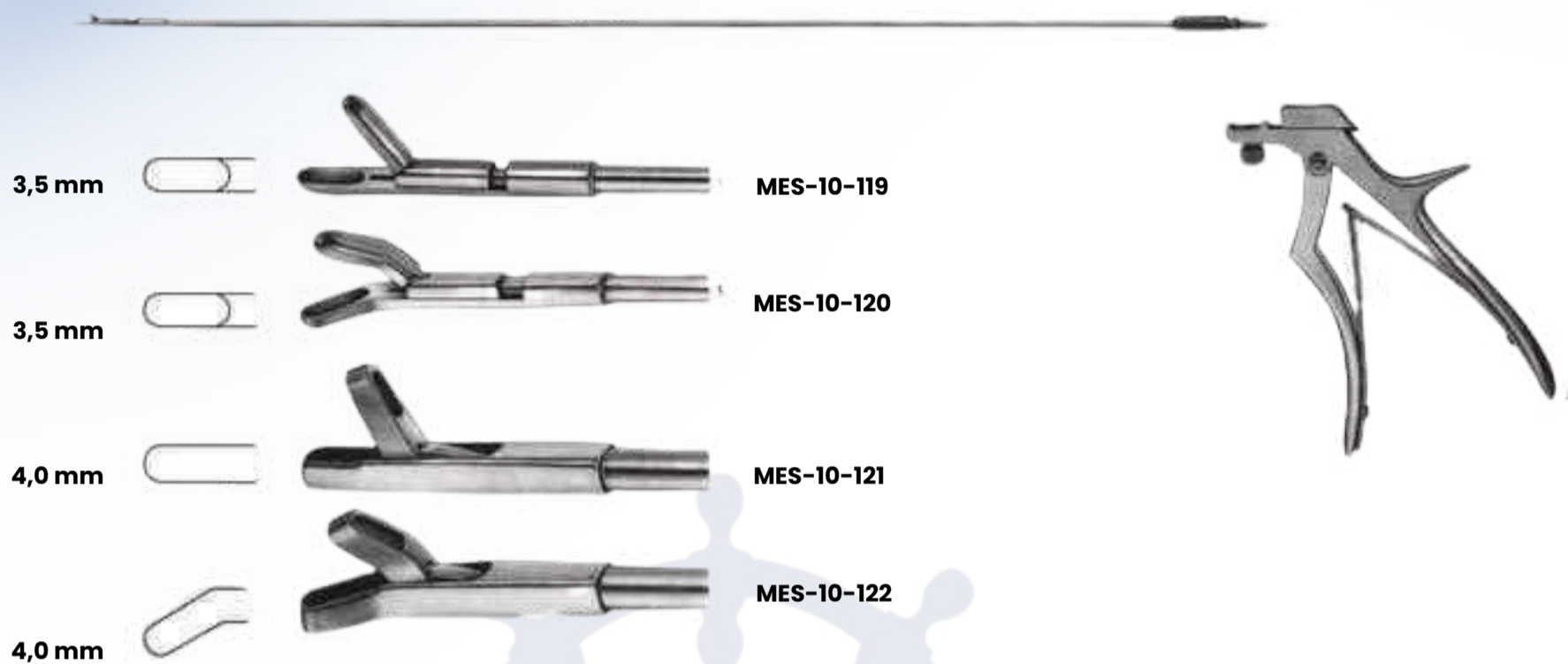

Haemorrhoidal Forceps

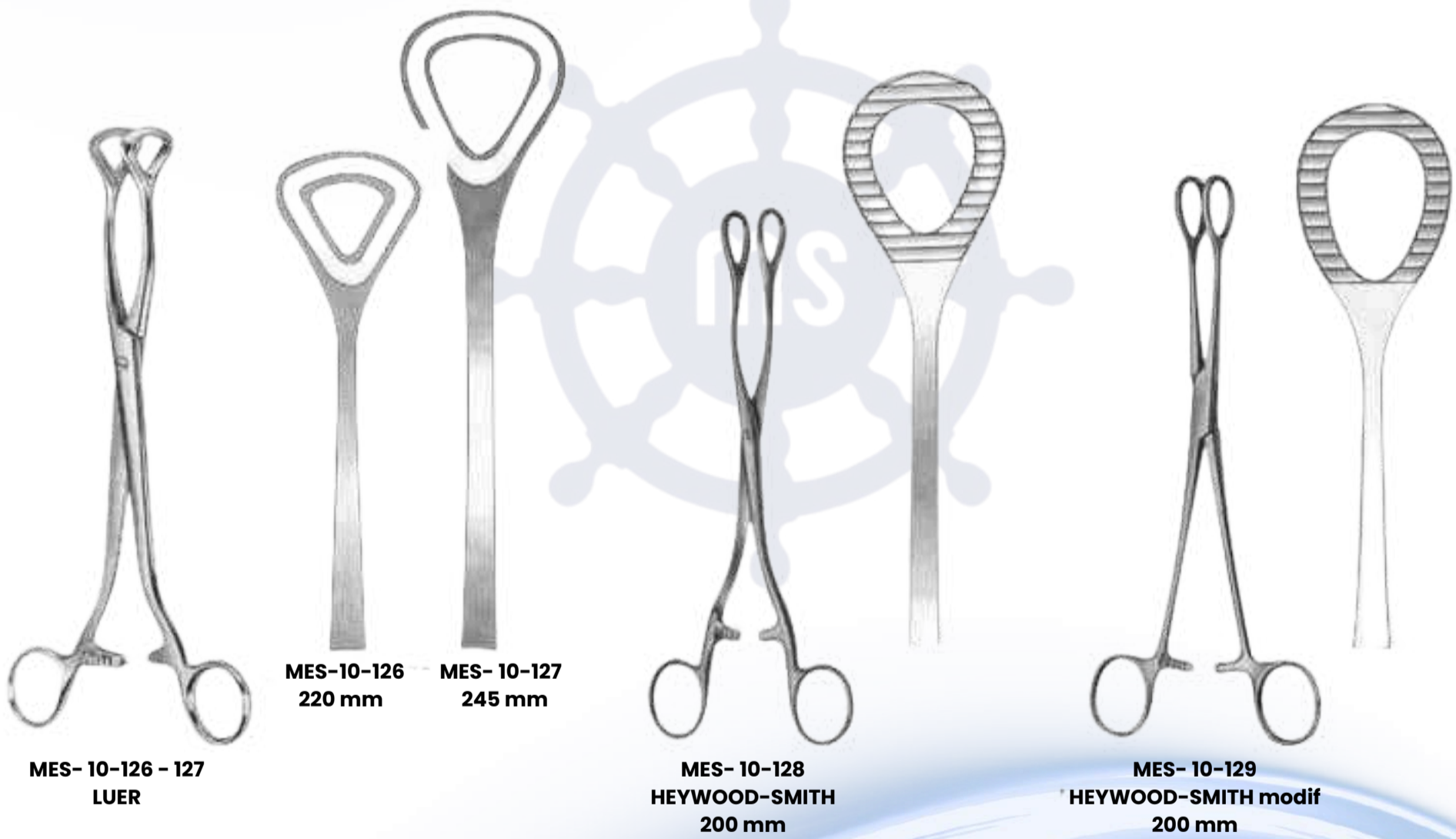

Haemorrhoidal Forceps

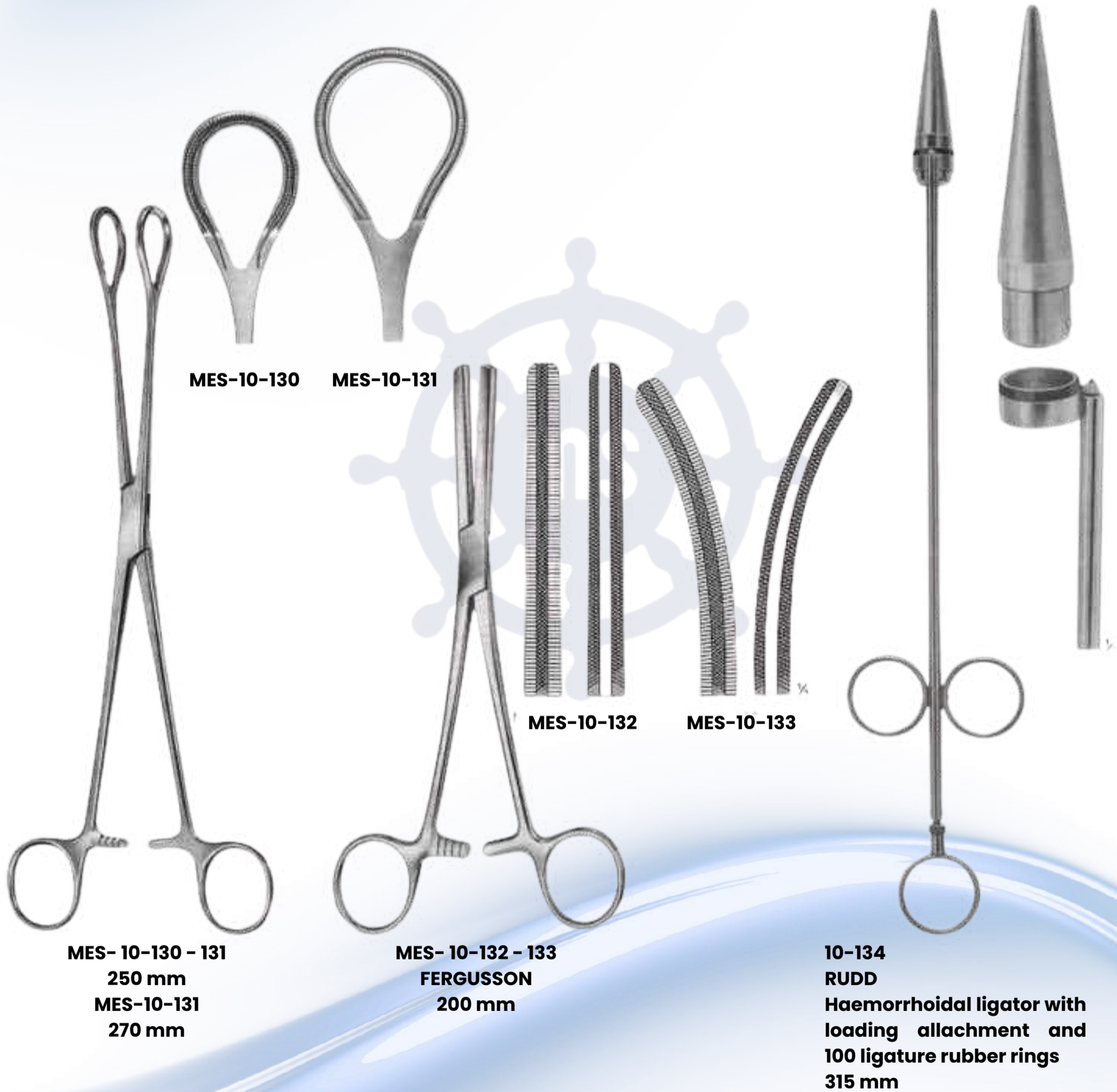

MES-10-130

MES-10-131

MES-10-132

MES-10-133

MES- 10-130 - 131
 250 mm
MES-10-131
 270 mm

MES- 10-132 - 133
FERGUSSON
 200 mm

10-134
RUDD
 Haemorrhoidal ligator with
 loading allachment and
 100 ligature rubber rings
 315 mm

Gall Duct Forceps



MES- 10-135
LOWER
180 mm



MES-10-136
LAHEY (SWEET)
190 mm



MES- 10-137
LAHEY
220 mm



MES-10-138
DESJARDINS
Gall duct-and cystic forceps
210 mm



MES- 10-139
NISSEN
Gall duct-and cystic forceps
215 mm

Gall Duct Forceps and Choledochus Forceps

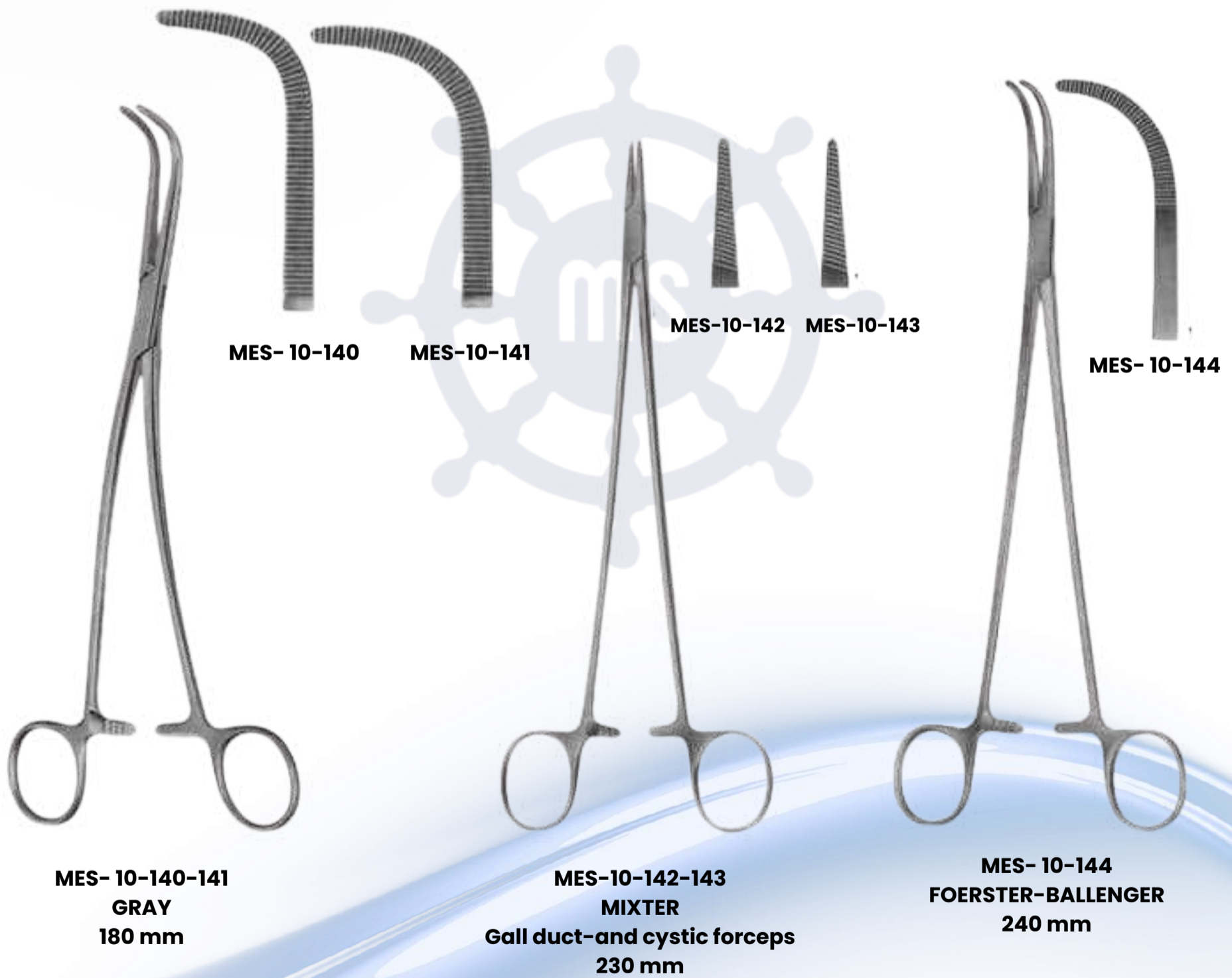

MES- 10-140-141
GRAY
180 mm

MES-10-142-143
MIXTER
Gall duct-and cystic forceps
230 mm

MES- 10-144
FOERSTER-BALLENGER
240 mm

Gall Bladder Forceps and Gall Duct Scissors



MES- 10-145
HEYWOOD-SMITH
250 mm



MES- 10-146
250 mm
MES-10-147
270 mm



MES-10-146
250 mm



MES-10-147
270 mm



MES- 10-148
HEYWOOD-SMITH
200 mm



MES-10-149
DOYEN
185 mm



MES-10-150 - 151
Gall duct scissors
200 mm



MES-10-150 **MES-10-151**
POTTS-DE **MILLS**
MARTEL

Gall Duct Probes



MES-10-152
HAJEK
 Irrigating
 cannula. silver
 165 mm



MES- 10-153
MOYNIHAN
 Gall duct probes,
 malleable
 365 mm



MES. 10-154
MAYO
 Gall duct probes.
 malleable
 330 mm



MES- 10-155
OCHSNER
 Gall duct probes,
 flexible
 400 mm



10-156 - 158
DESJARDINS
 Gall duct probes,
 flexible
 285 mm



MES- 10-156



MES- 10-157



MES- 10-158

Gall Duct Dilators & Gall Stone Scoops

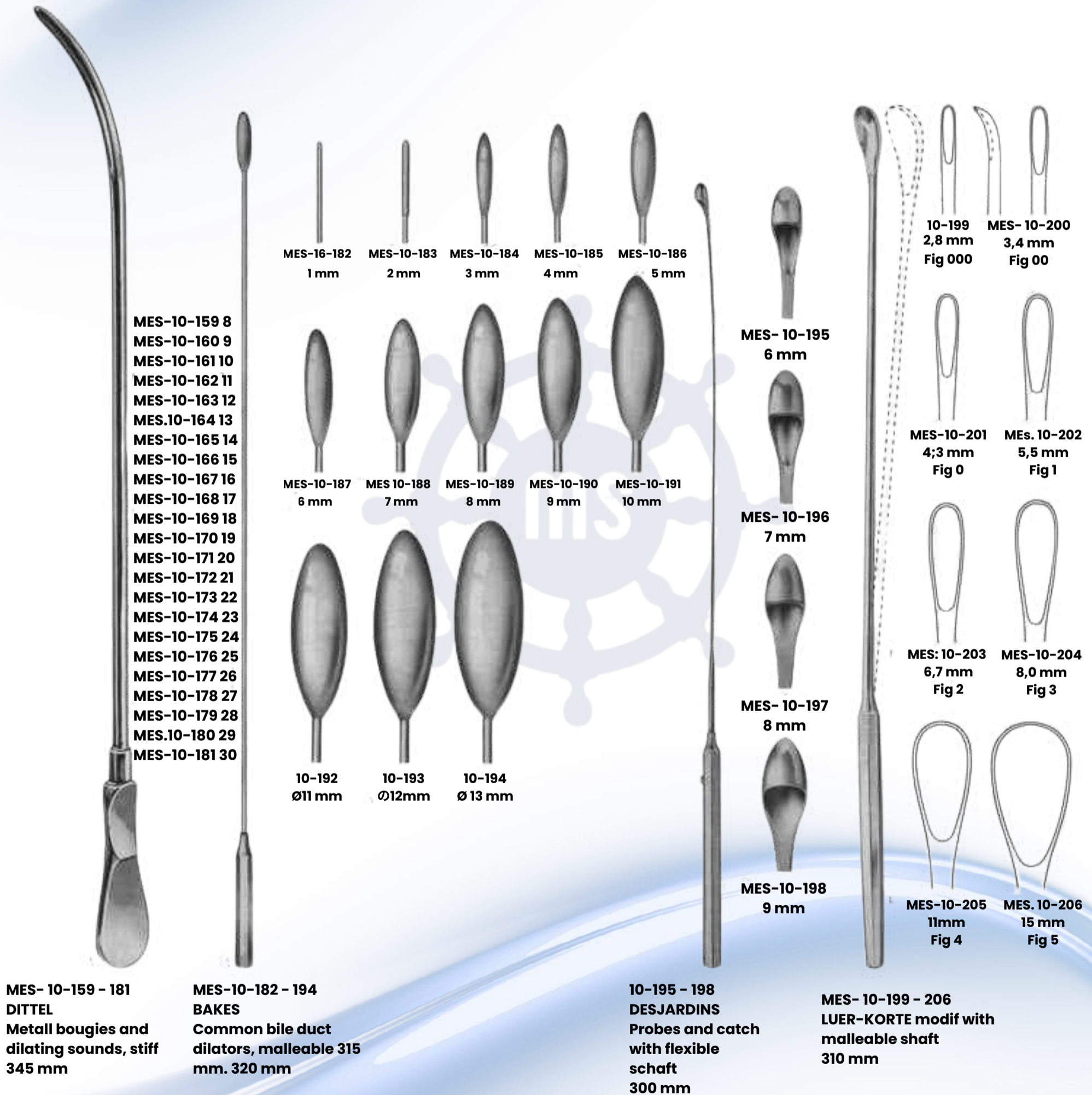

MES-10-159 8
MES-10-160 9
MES-10-161 10
MES-10-162 11
MES-10-163 12
MES.10-164 13
MES-10-165 14
MES-10-166 15
MES-10-167 16
MES-10-168 17
MES-10-169 18
MES-10-170 19
MES-10-171 20
MES-10-172 21
MES-10-173 22
MES-10-174 23
MES-10-175 24
MES-10-176 25
MES-10-177 26
MES-10-178 27
MES-10-179 28
MES.10-180 29
MES-10-181 30

MES-16-182
1 mm
MES-10-183
2 mm
MES-10-184
3 mm
MES-10-185
4 mm
MES-10-186
5 mm
MES-10-187
6 mm
MES 10-188
7 mm
MES-10-189
8 mm
MES-10-190
9 mm
MES-10-191
10 mm
10-192
Ø11 mm
10-193
Ø12mm
10-194
Ø13 mm
MES- 10-195
6 mm
MES- 10-196
7 mm
MES- 10-197
8 mm
MES-10-198
9 mm
10-199
2,8 mm
Fig 000
MES- 10-200
3,4 mm
Fig 00
MES-10-201
4,3 mm
Fig 0
MES. 10-202
5,5 mm
Fig 1
MES: 10-203
6,7 mm
Fig 2
MES-10-204
8,0 mm
Fig 3
MES-10-205
11mm
Fig 4
MES. 10-206
15 mm
Fig 5

MES- 10-159 - 181
DITTEL
 Metall bougies and dilating sounds, stiff 345 mm

MES-10-182 - 194
BAKES
 Common bile duct dilators, malleable 315 mm. 320 mm

10-195 - 198
DESJARDINS
 Probes and catch with flexible shaft 300 mm

MES- 10-199 - 206
LUER-KORTE modif with malleable shaft 310 mm

Gall Stone Forceps



MES- 10-207
BLAKE
 205 mm



MES: 10-208
BLAKE
 205 mm



MES- 10-209
CZERNY
 245 mm



MES- 10-210-213
DESJARDINS
 225 mm



MES-10-210

MES. 10-211

MES-10-212 MES-10-213

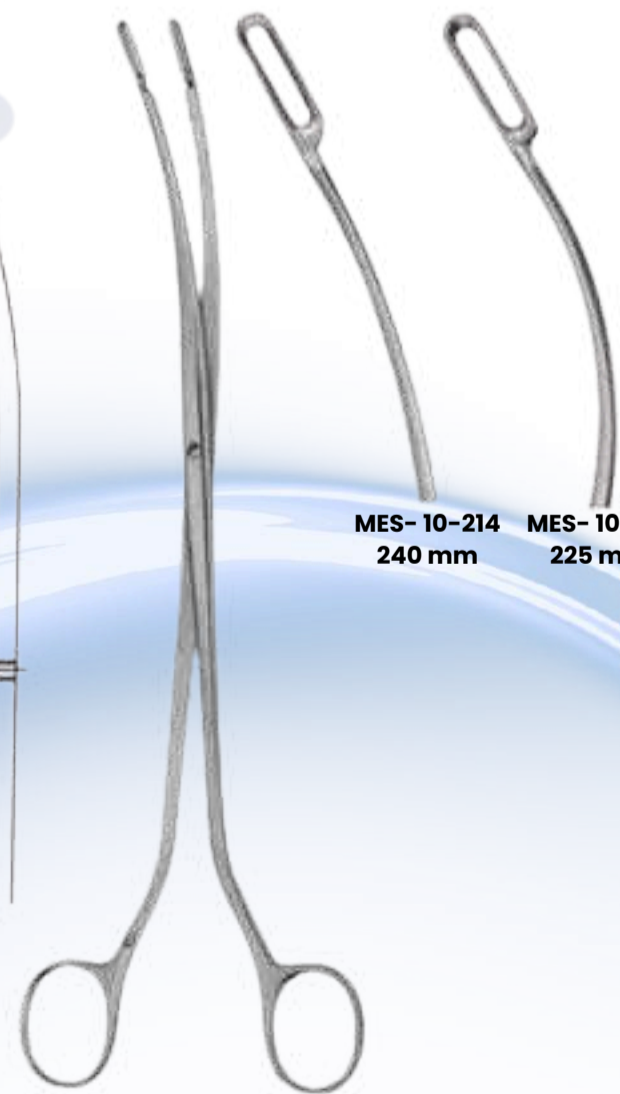

MES- 10-214
240 mm

MES- 10-215
225 mm

MES-10-214 - 215
DESJARDINS
 Extremely delicate patterns

[Back to index](#)

Obstetrics-Placenta and Ovum Forceps



Obstetrics-Placenta and Ovum Forceps



MES-16-130
SAENGER
285 mm



MES-16-131
SAENGER
285 mm



16-132

16-133



MES-16-132 - 133
LEWKOWIZ
245mm

Obstetrics-Placenta, Ovum and Cranioclast, Basiotribe Forceps

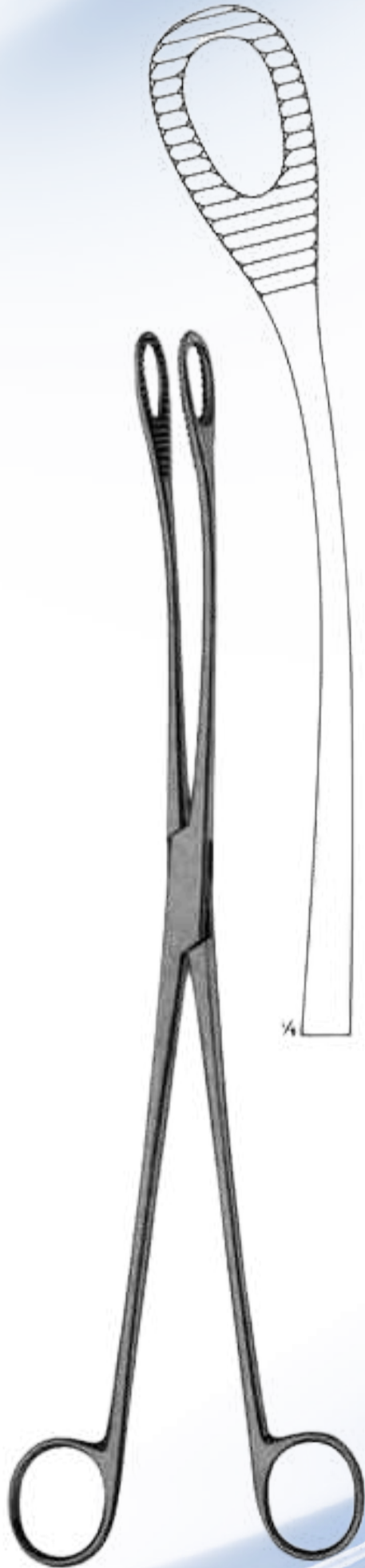

MES-16-134
KELLY
320mm



MES-16-135
SMELLIE
Perforator
270mm



MES-16-136
BRAUN
Cranioclast
420mm

Obstetrics-Placenta and Ovum Forceps



Obstetrics-Placenta and Ovum Forceps



MES-16-130
SAENGER
285 mm



MES-16-131
SAENGER
285 mm



16-132

16-133



MES-16-132 - 133
LEWKOWIZ
245mm

Obstetrics-Placenta, Ovum and Cranioclast, Basiotribe Forceps

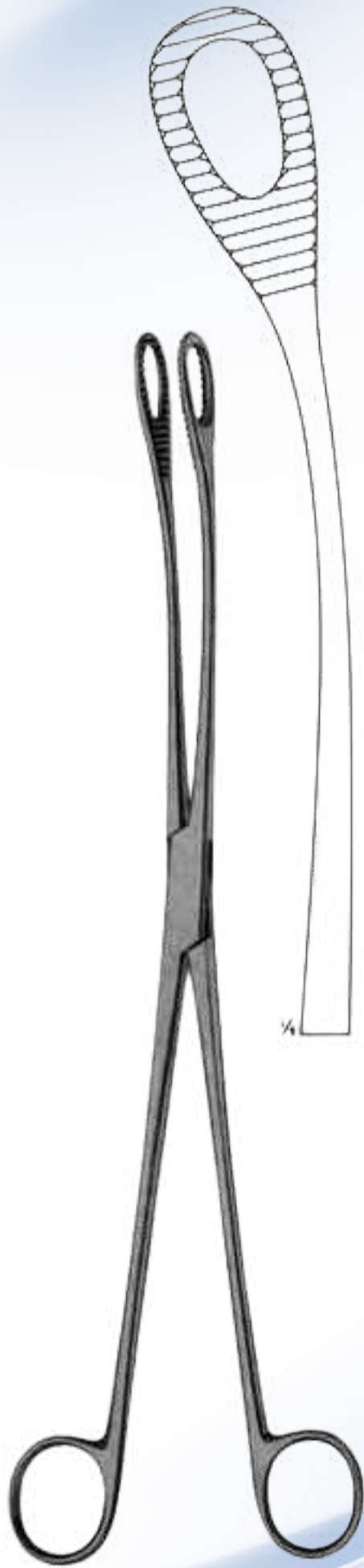

MES-16-134
KELLY
320mm

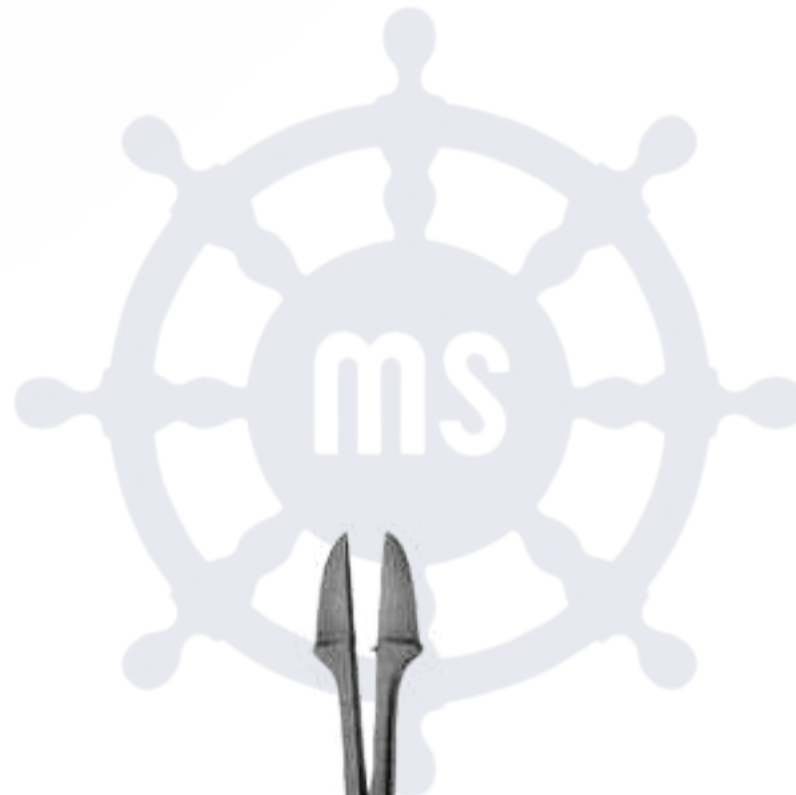

MES-16-135
SMELLIE
Perforator
270mm



MES-16-136
BRAUN
Cranioclast
420mm