



شركة الخدمات البحرية المحدودة  
MARINE SERVICES CO., LTD.



# Surgical Clamps Instruments

Precision • Quality • Reliability

## Hemostatic / General Clamps

1. Non-Traumatic Hemostatic Forceps
2. Multi-Purpose Clamps

## Intestinal Clamps

1. Intestinal Clamps
2. Soft Elastic Intestinal Clamps
3. Intestinal Clamps for Children

## Anastomosis Clamps

1. Anastomosis Clamps
2. Anastomosis Multi-Purpose Clamps (Neonatales)
3. Anastomosis-and Multi-Purpose-Clamps-Pediatric types
4. Aorta-Anastomosis Clamps

## Vascular Clamps

1. Ring Handle Bulldog Clamps
2. Vena-Cava Clamps

ISO 13485 AND CE

Manufactured & supplied in compliance with international medical standards.

## Non-traumatic Haemostatic Forceps



## Non-traumatic Haemostatic Forceps

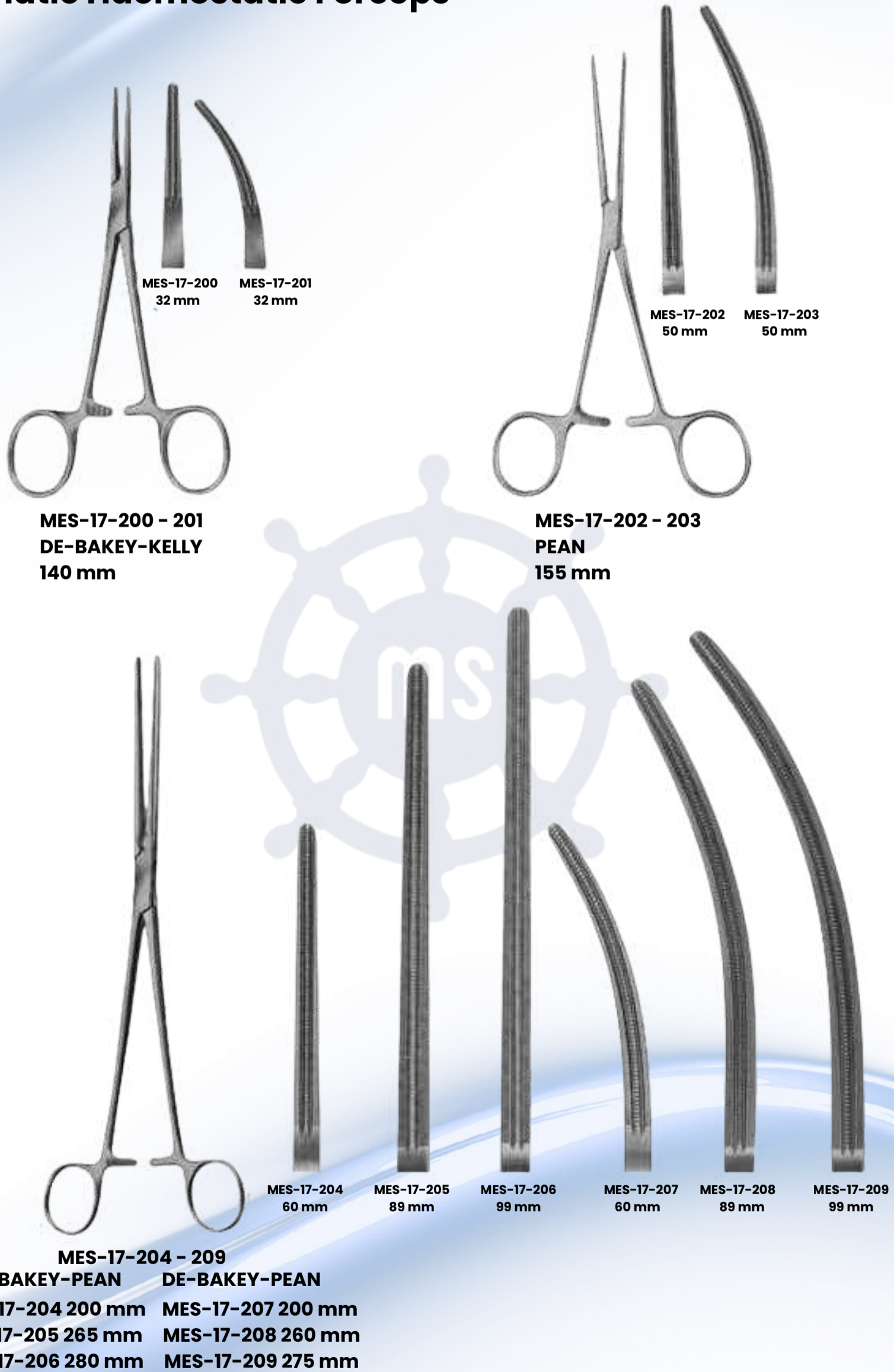

[Back to index](#)

## Multi-Purpose Clamps

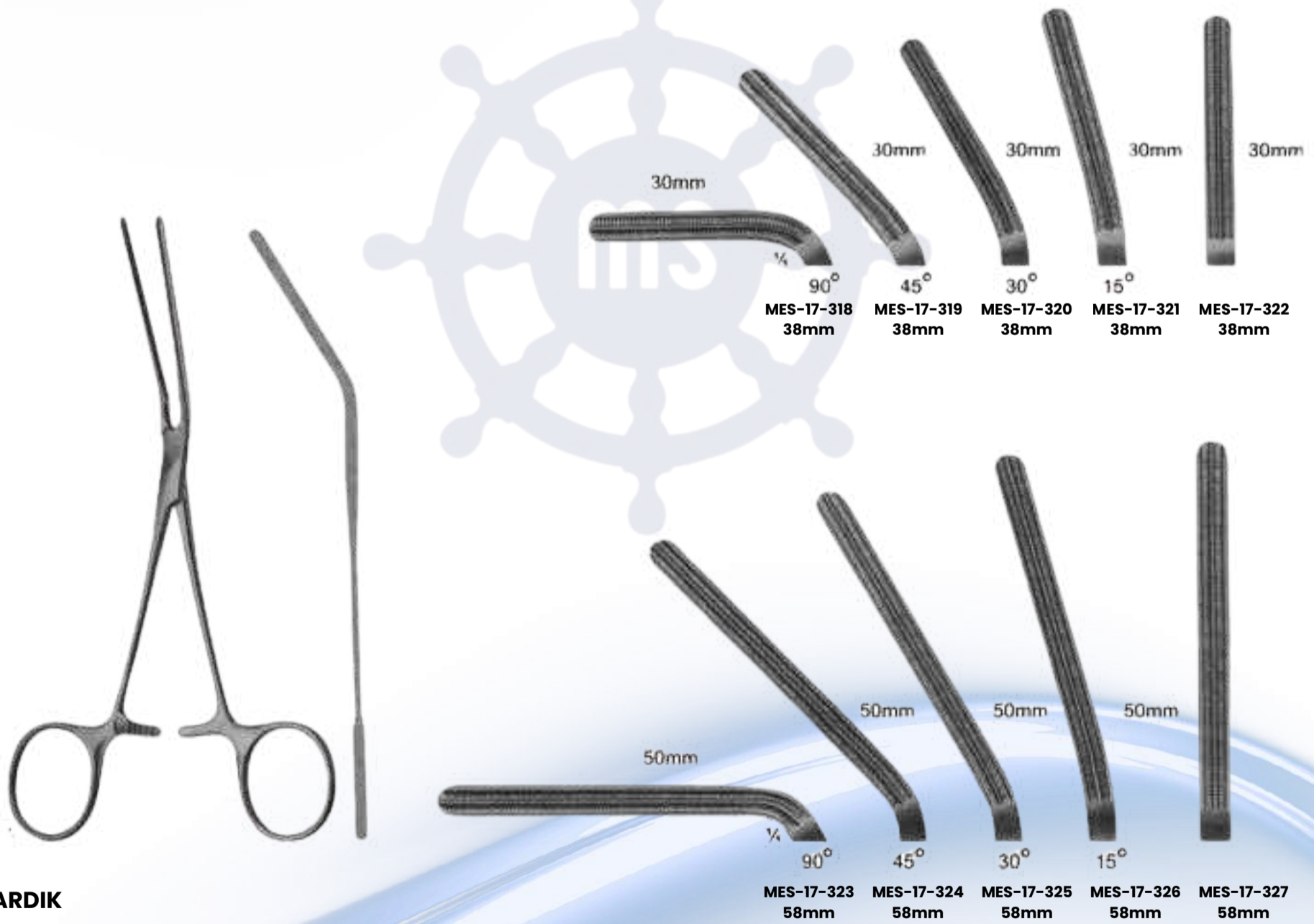

**DARDIK**

MES-17-318	150 mm	MES-17-323	170 mm
MES-17-319	150 mm	MES-17-324	170 mm
MES-17-320	150 mm	MES-17-325	170 mm
MES-17-321	145 mm	MES-17-326	160 mm
MES-17-322	130 mm	MES-17-327	135 mm

MES-17-323	58mm	MES-17-324	58mm	MES-17-325	58mm	MES-17-326	58mm	MES-17-327	58mm
------------	------	------------	------	------------	------	------------	------	------------	------

## Multi-Purpose Clamps



**MES-17-328**  
**WILLIAMS**  
 160 mm



**MES-17-329**  
**TUTTLE**  
 230 mm



**MES-17-330**  
**NELSON**  
 230 mm



**MES-17-331**  
**DUVAL**  
 230 mm



**MES-17-332**



**MES-17-333**



**MES-17-334**



**BABCOCK**  
**MES-17-332** 170 mm  
**MES-17-333** 215 mm  
**MES-17-334** 220 mm



**MES-17-335**  
**ALLIS**  
 220 mm

## Multi-Purpose Clamps



**MES-17-336**  
**FINOCHIETTO**  
245 mm



**MES-17-337 - 338**  
**SEMB**  
244 mm



**MES-17-339**  
**WIKSTROEM**  
205 mm

## Multi-Purpose Clamps



**MES-17-340**  
**MIXTER**  
**230 mm**

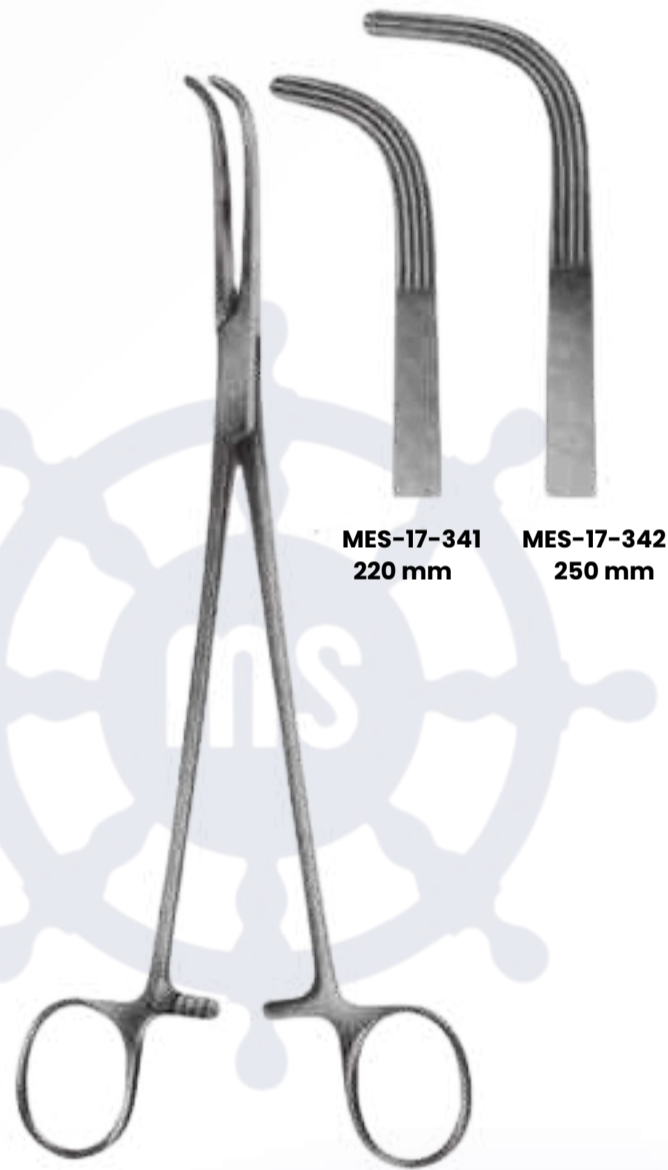

**MES-17-341**    **MES-17-342**  
**220 mm**        **250 mm**

**MES-17-341 - 342**  
**MIXTER**



**MES-17-343**  
**HOPENER**  
**160 mm**

## Multi-Purpose Clamps

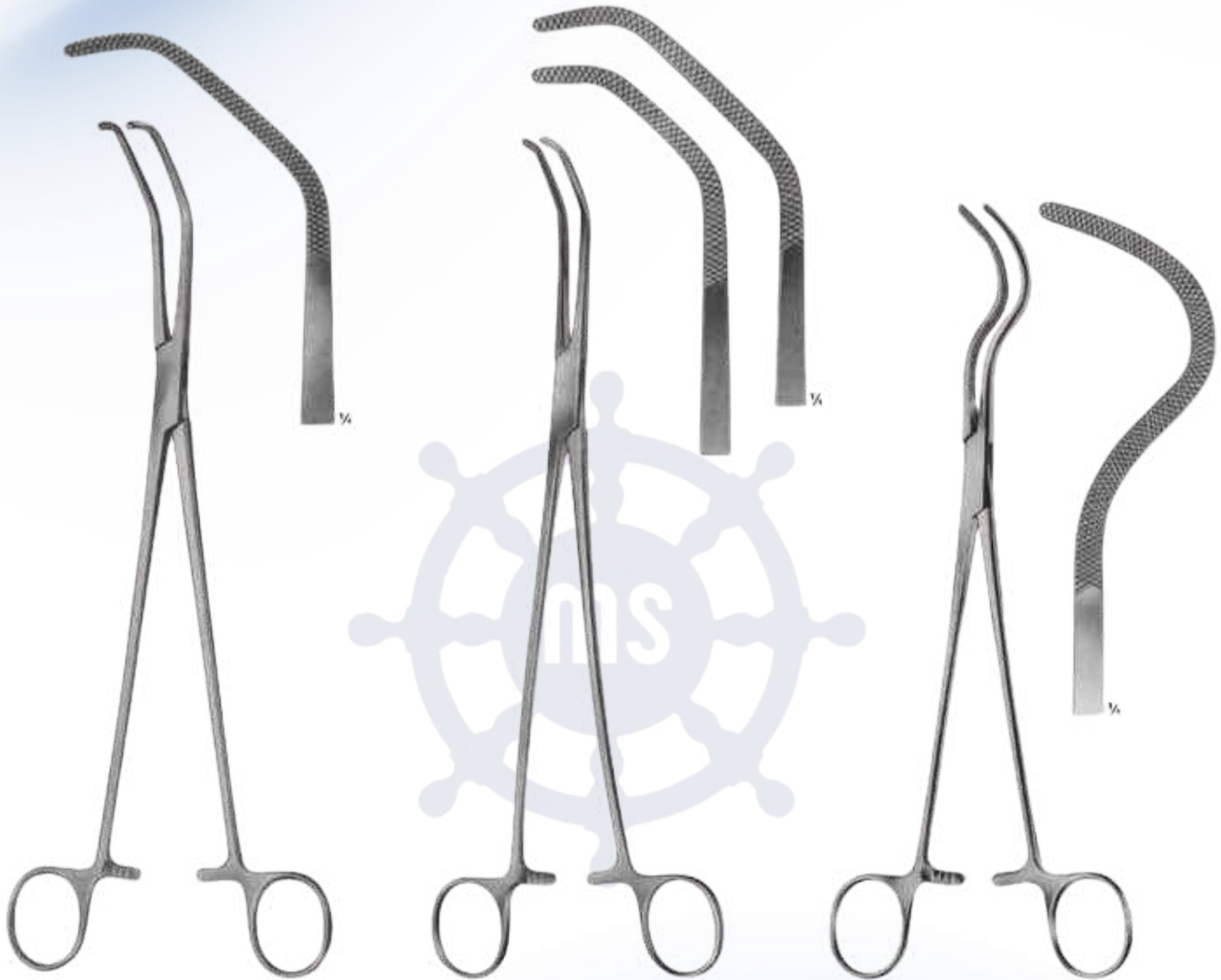

**MES-17-344**  
**SATINSKY**  
**265 mm**

**MES-17-345**  
**SATINSKY**  
**265mm**

**MES-17-346**  
**HARKEN**  
**240 mm**

## Multi-Purpose Clamps



**MES-17-347**  
**PERTUISET**  
**Carotid Clamp**  
**90 mm**



**MES-17-348**  
**CRAFOORD-SELLORS**  
**240 mm**



**MES-17-349 - 350**  
**CRAFOORD**  
**240 mm**

**MES-17-349**   **MES-17-350**

## Multi-Purpose Clamps



**MES-17-351**  
**PRICE THOMAS**  
225 mm



**MES-17-352 - 353**  
**PRICE THOMAS**  
225 mm



**MES-17-352**  
jaws with pins



**MES-17-353**  
jaws with pins

## Intestinal Clamps, Soft Elastic

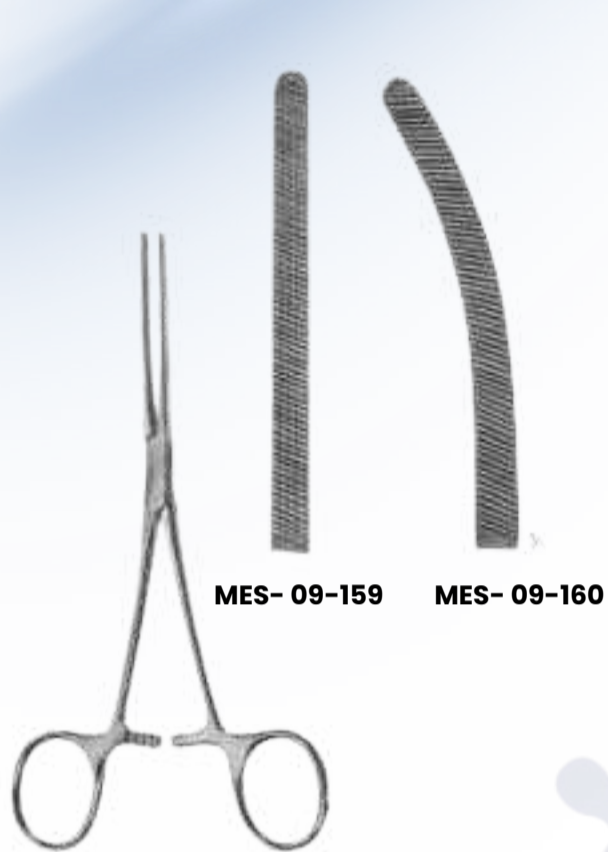

MES- 09-159    MES- 09-160

**MES- 09-159 - 160**  
**DOYEN elastic**  
**165 mm**

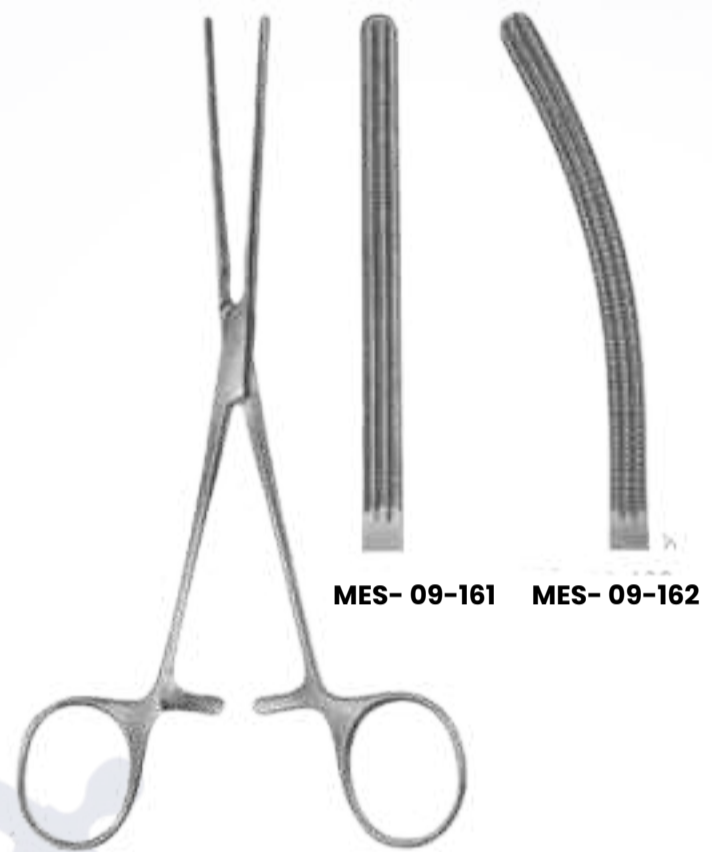

MES- 09-161    MES- 09-162

**MES- 09-161 - 162**  
**DOYEN**  
**with elastic blades**  
**170 mm**



MES- 09-163    MES- 09-164

**MES- 09-163 - 164**  
**HARTMANN**  
**with elastic blades**  
**200mm**



MES- 09-165    MES- 09-166

**MES- 09-165 - 166**  
**HARTMANN**  
**with elastic blades**  
**200 mm**

[Back to index](#)

## Intestinal Clamps, Soft elastic

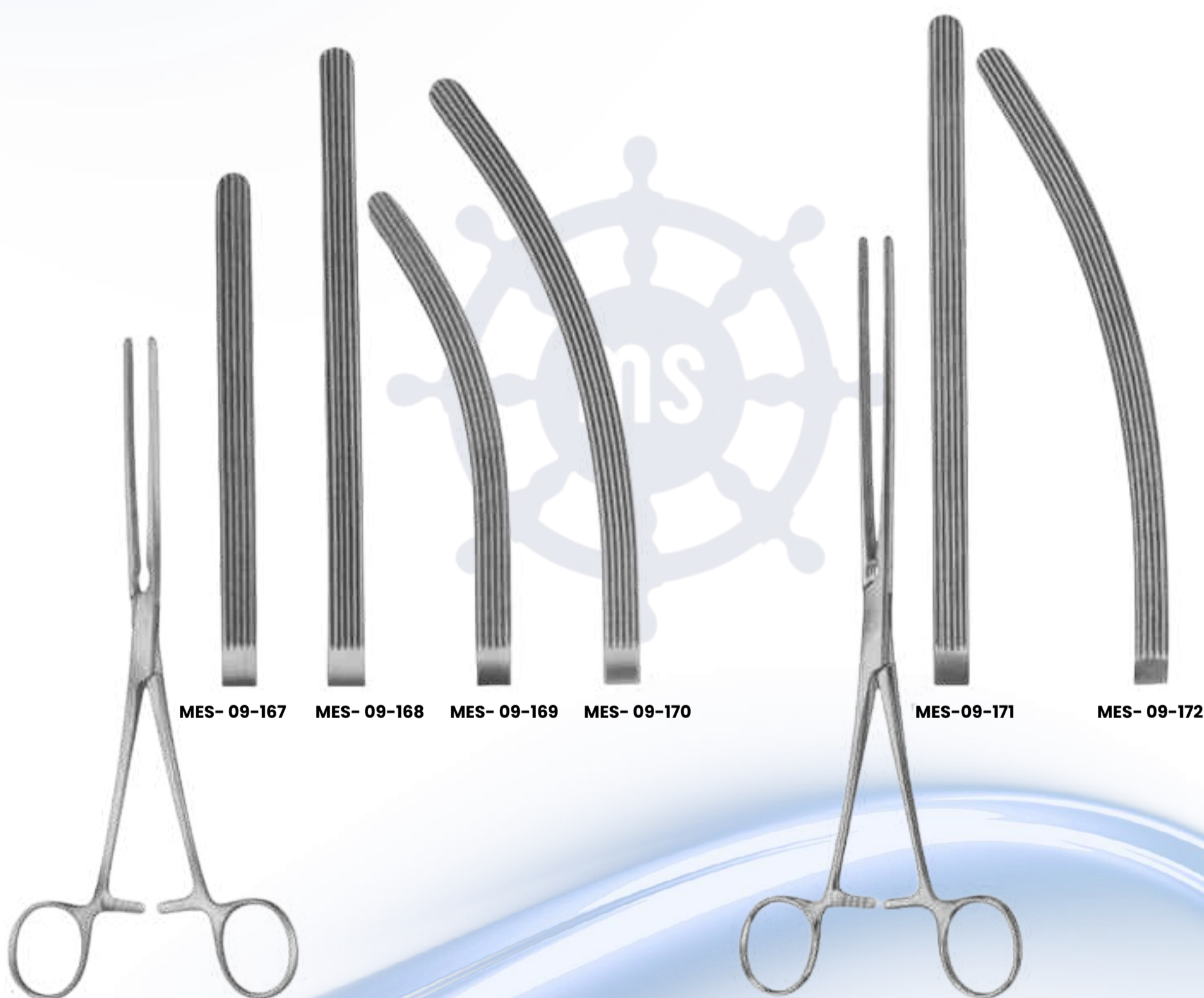

**MES• 09-167 - 170**  
**KOCHER**  
**with elastic blades**  
**MES-09-169 210 mm**  
**MES-09-170 230 mm**

**MES- 09-171 - 172**  
**DOYEN**  
**with elastic blades**  
**210 mm**

## Intestinal Clamps, Soft elastic



MES- 09-173



MES- 09-174



MES- 09-175



MES- 09-176

**MES- 3-173 - 174**  
**DOYEN**  
**with elastic blades**  
**235 mm**

**MES-09-175 - 176**  
**DOYEN**  
**with elastic blades**  
**230 mm**

## Intestinal Clamps, Soft elastic

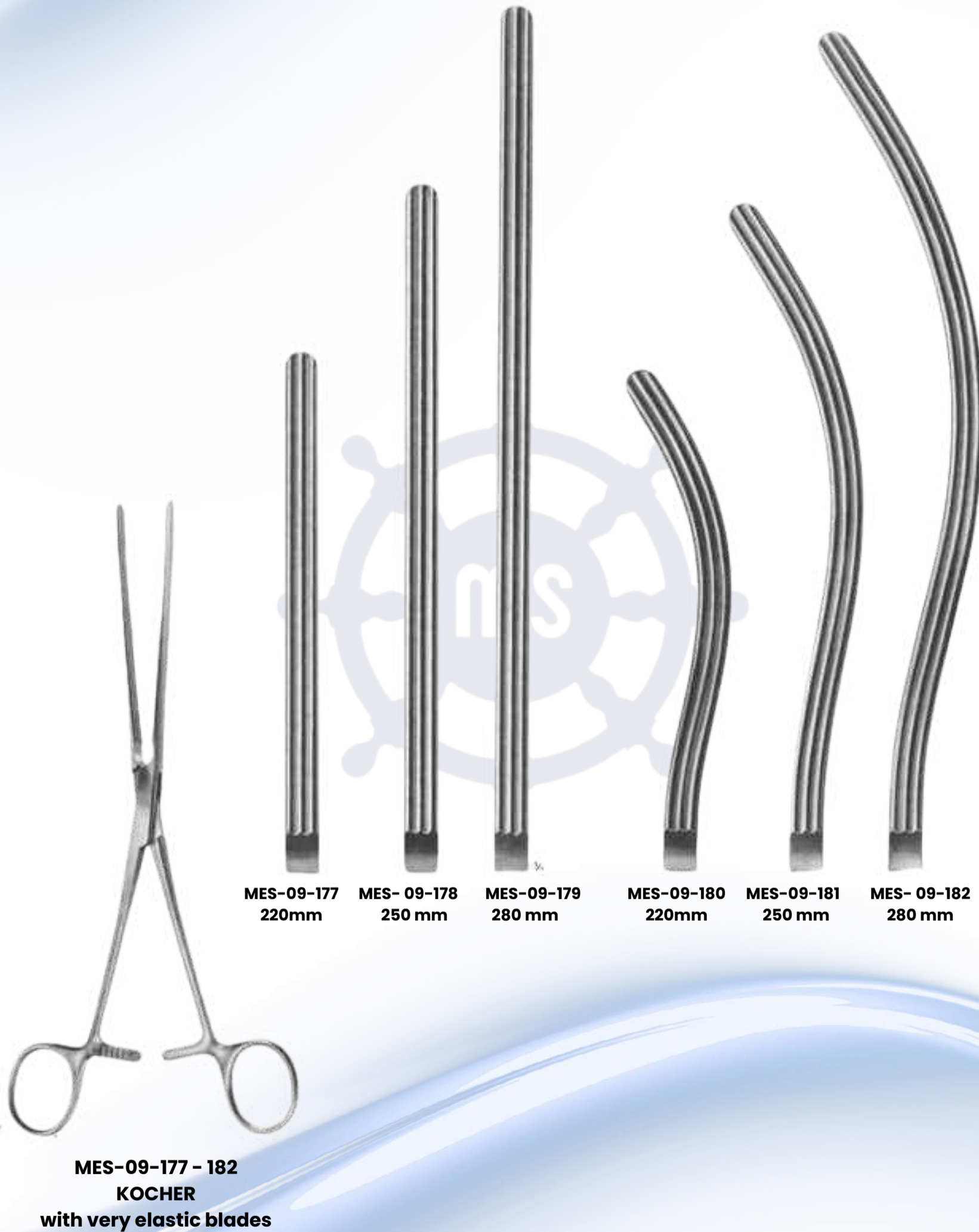

## Intestinal Clamps, Soft elastic

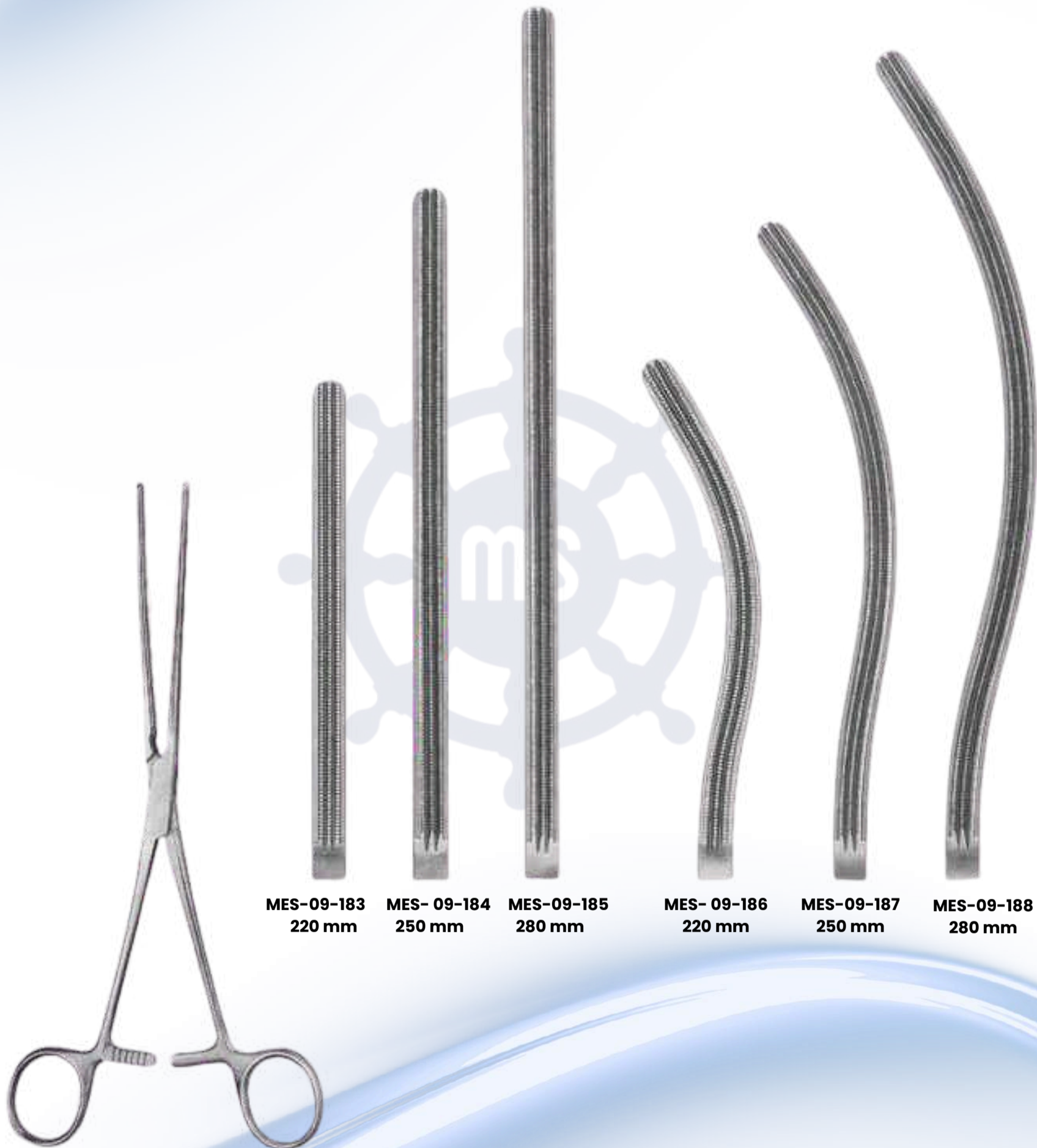

**MES-09-183**  
220 mm

**MES-09-184**  
250 mm

**MES-09-185**  
280 mm

**MES-09-186**  
220 mm

**MES-09-187**  
250 mm

**MES-09-188**  
280 mm

**MES-09-183 - 188**  
**KOCHER**  
with very elastic blades

## Intestinal Clamps



MES-09-189



MES- 09-190



MES- 09-191

MES- 09-189 - 190  
NUSSBAUM  
with elastic blades  
250 mm

MES-09-191  
MOYNIHAN  
280 mm

## Intestinal Clamps



MES- 09-192

**MES-09-192 - 193**  
**MAYO-ROBSON**  
 hard elastic  
 250 mm



MES- 09-193



MES- 09-194

**MES- 09-194 - 195**  
**MAYO-ROBSON**  
 250 mm

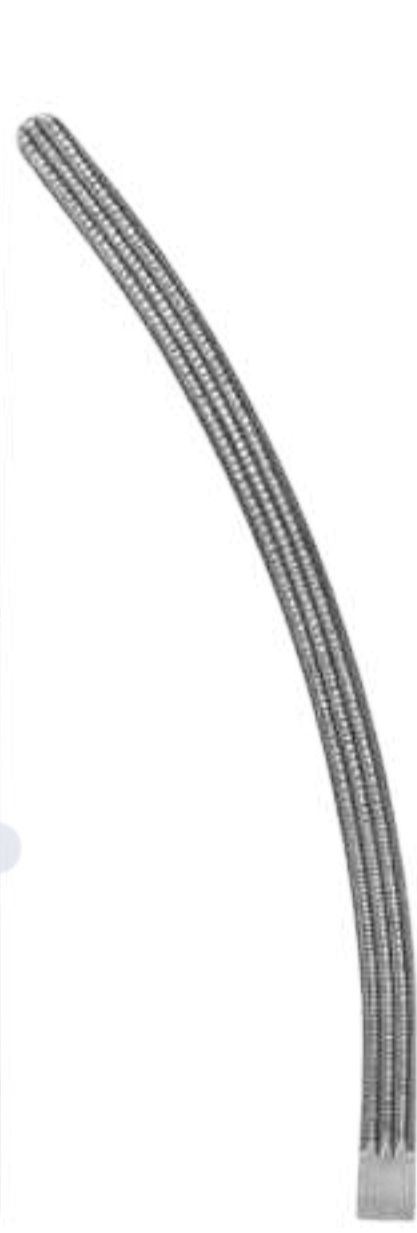

MES- 09-195

## Intestinal Clamps for Children



MES-09-152

MES-09-153

**MES- 09-152 - 153**  
**BAINBRIDGE**  
**155 mm**

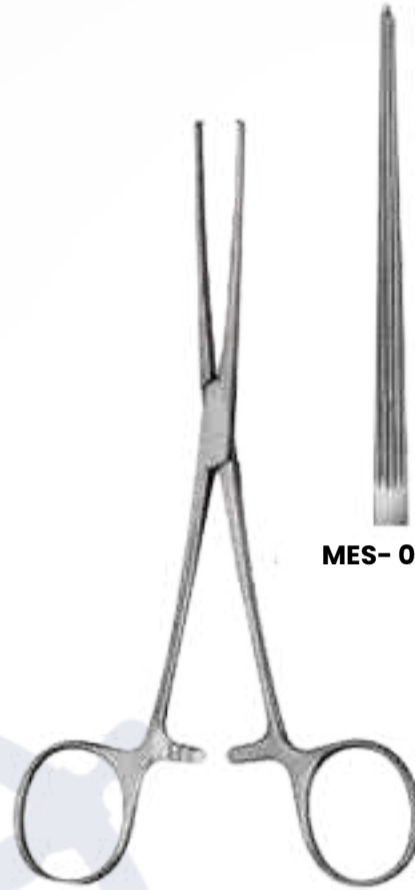

MES- 09-154

**MES- 09-154**  
**ALLEN**  
**155 mm**



MES-09-155

MES- 09-156

**MES- 09-155 - 156**  
**BABY-KOCHER**  
**very elastic blades**  
**130 mm**

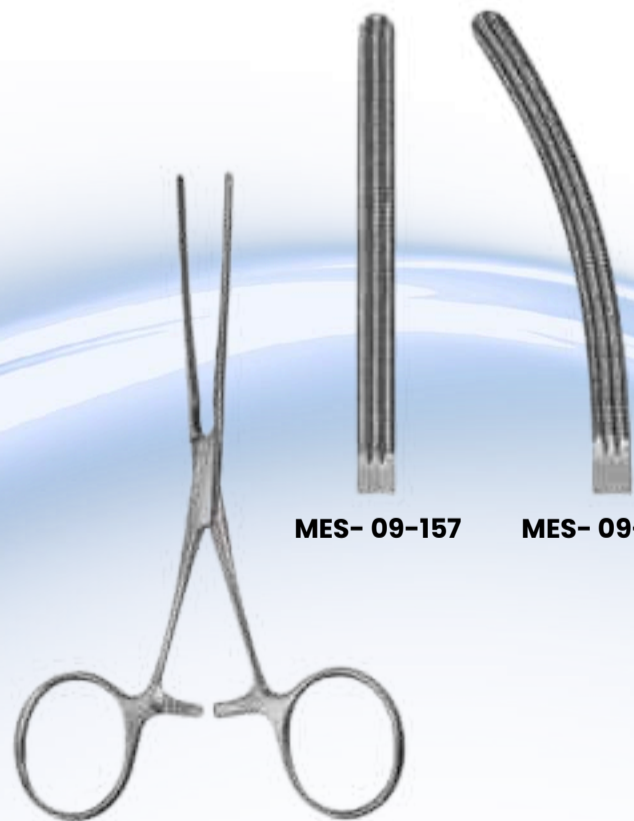

MES- 09-157

MES- 09-158

**09-157 - 158**  
**BABY-KOCHER with**  
**elastic blades**  
**130 mm**

[Back to index](#)

## Anastomosis Clamps

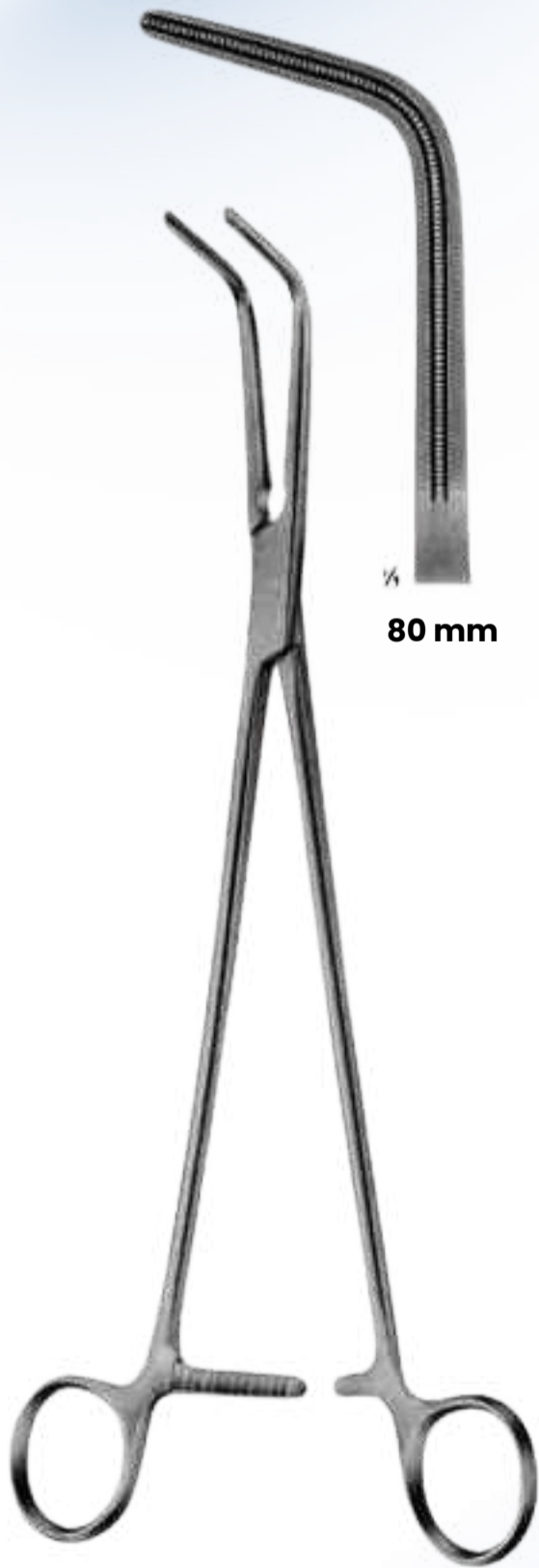

**MES-17-210**  
**DE-BAKEY-MIXTER**  
**285 mm**

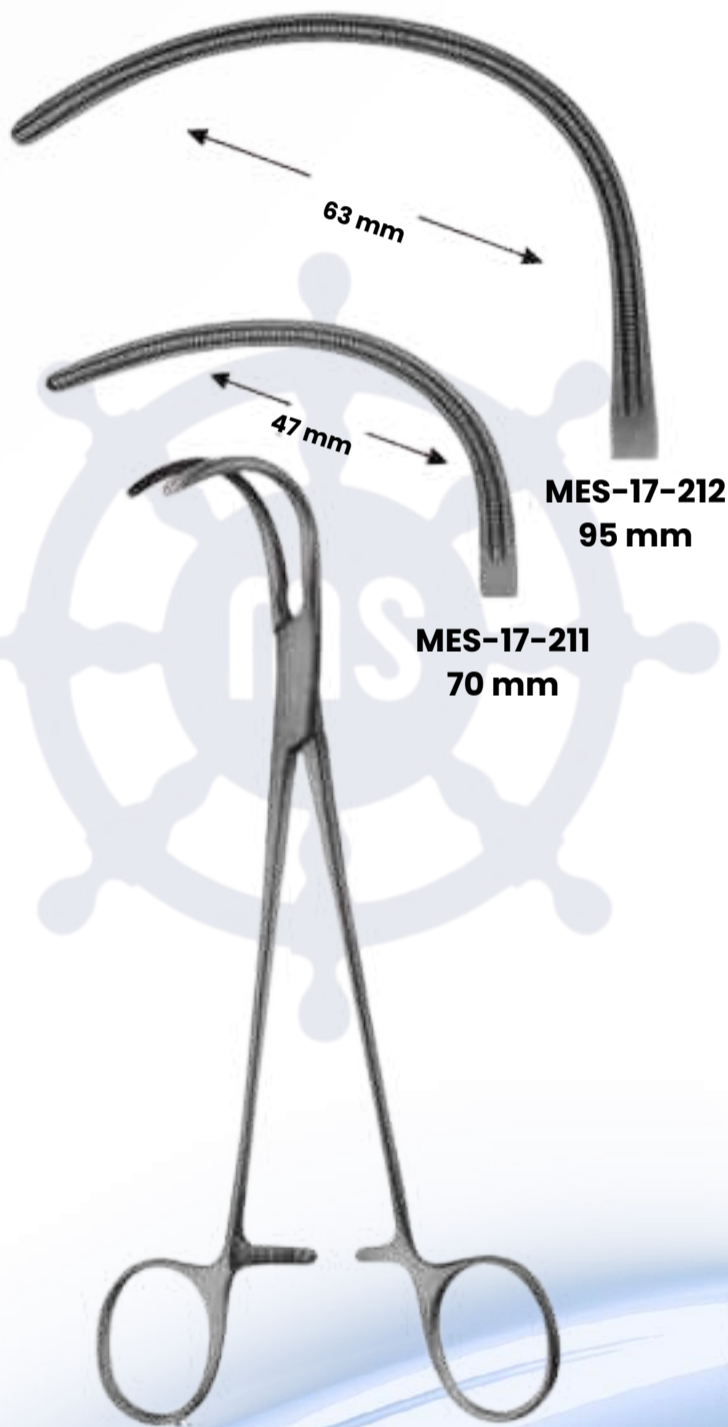

**MES-17-211-212**  
**GLOVER**  
**245 mm**



**MES-17-213**  
**GLOVER**  
**220 mm**

## Anastomosis-and Multi-Purpose-Clamps for Neonatales

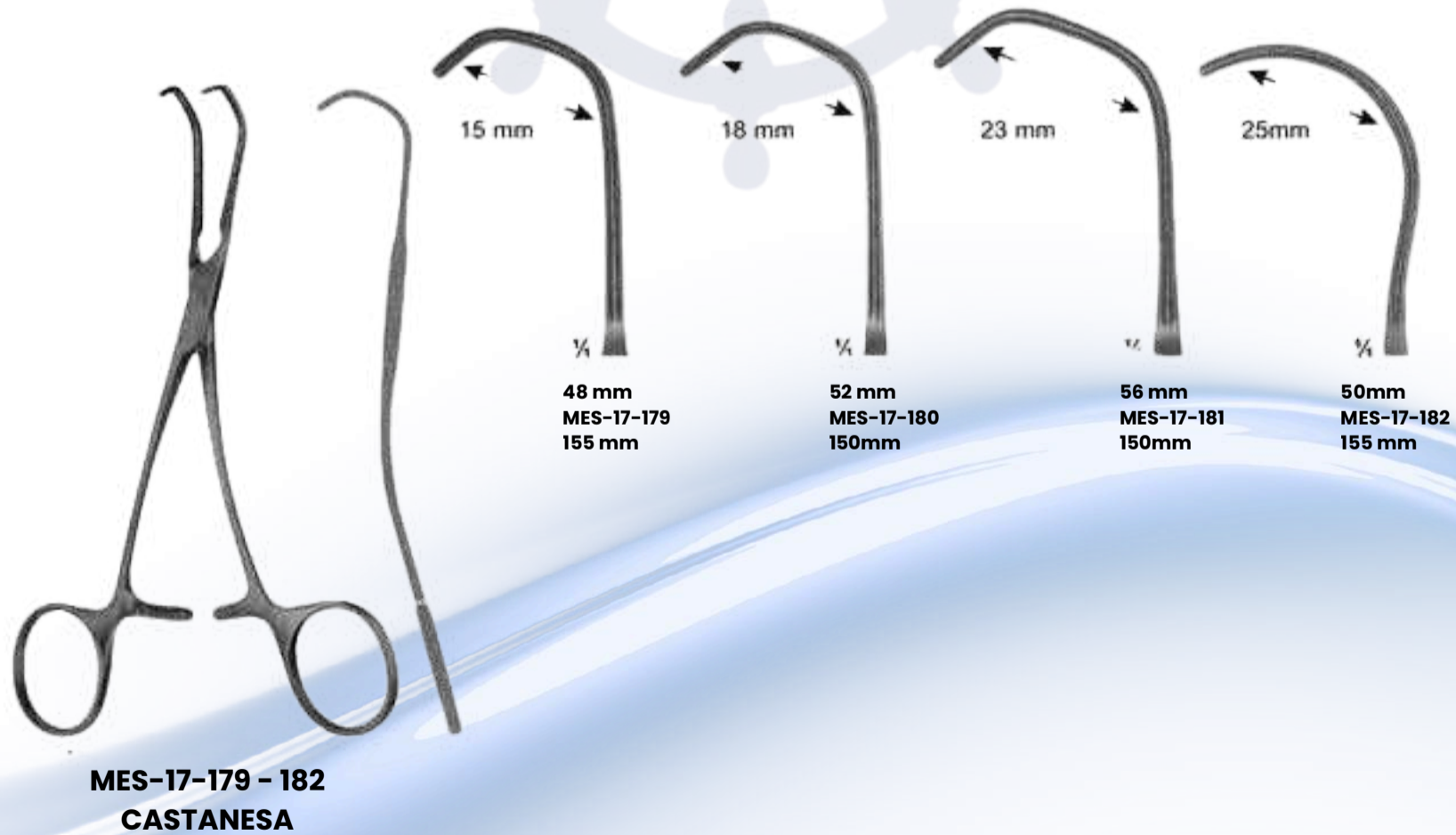
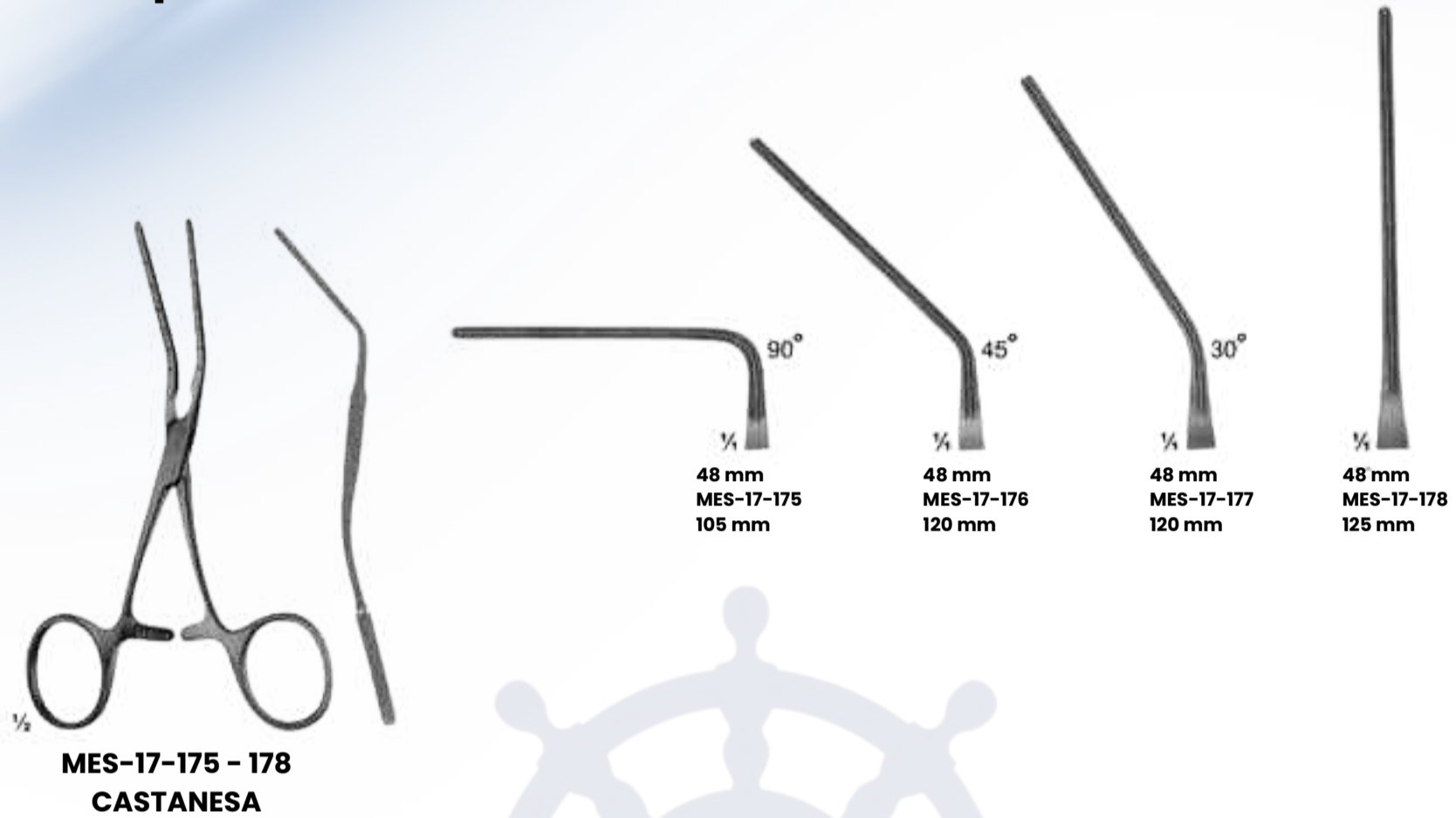

## Anastomosis-and Multi-Purpose-Clamps-Pediatric types

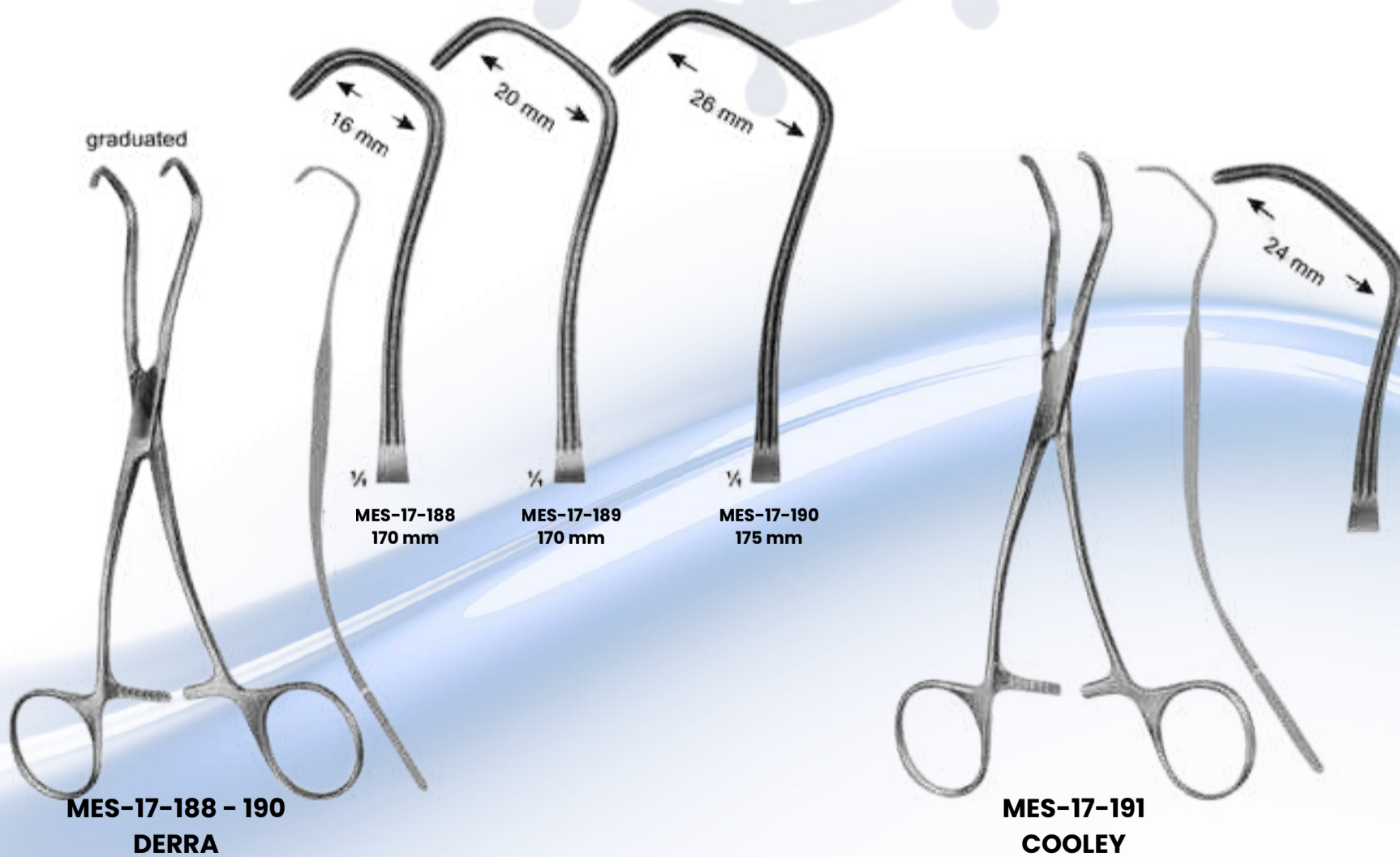
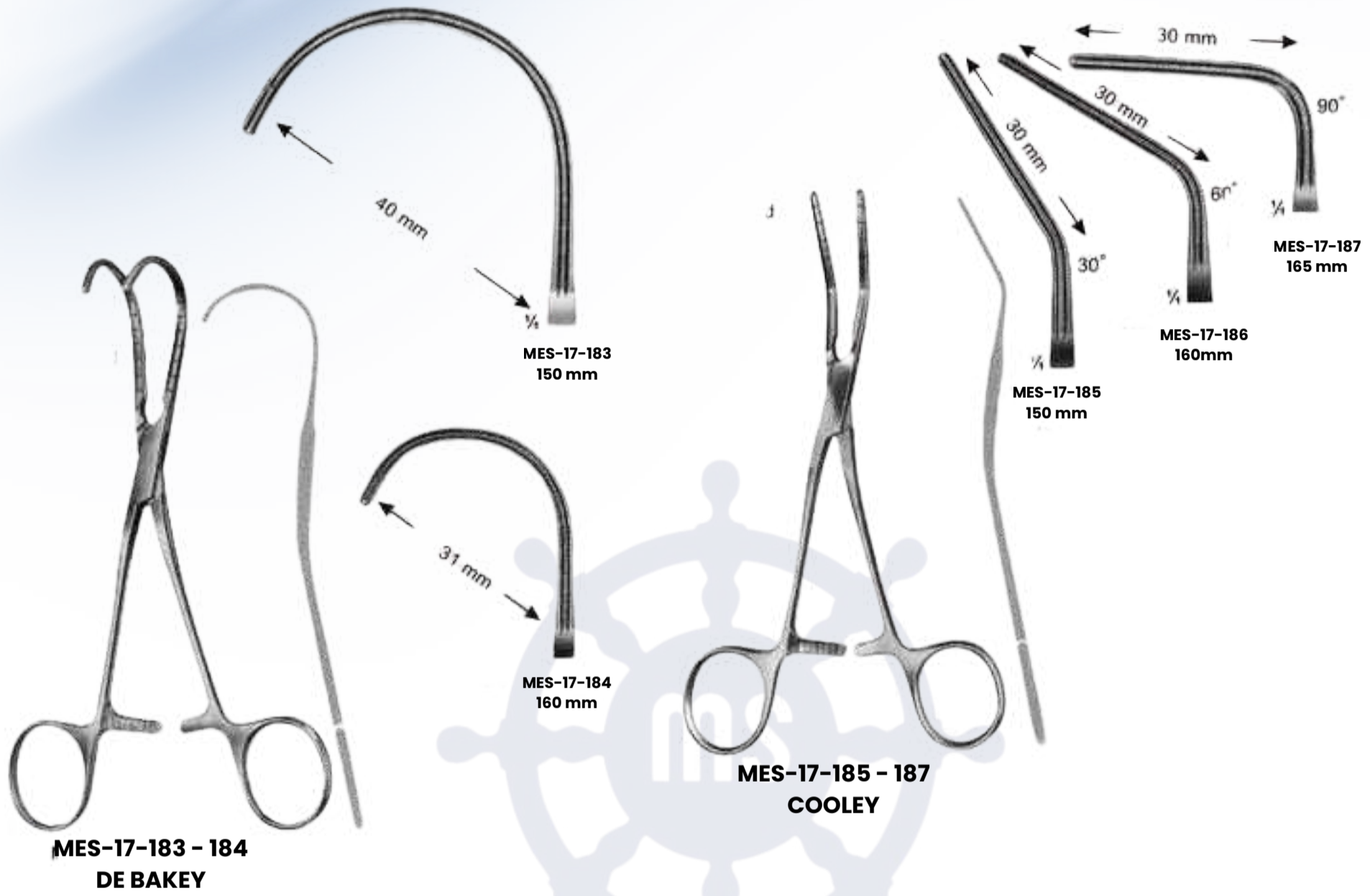

[Back to index](#)

## Aorta-Anastomosis Clamps

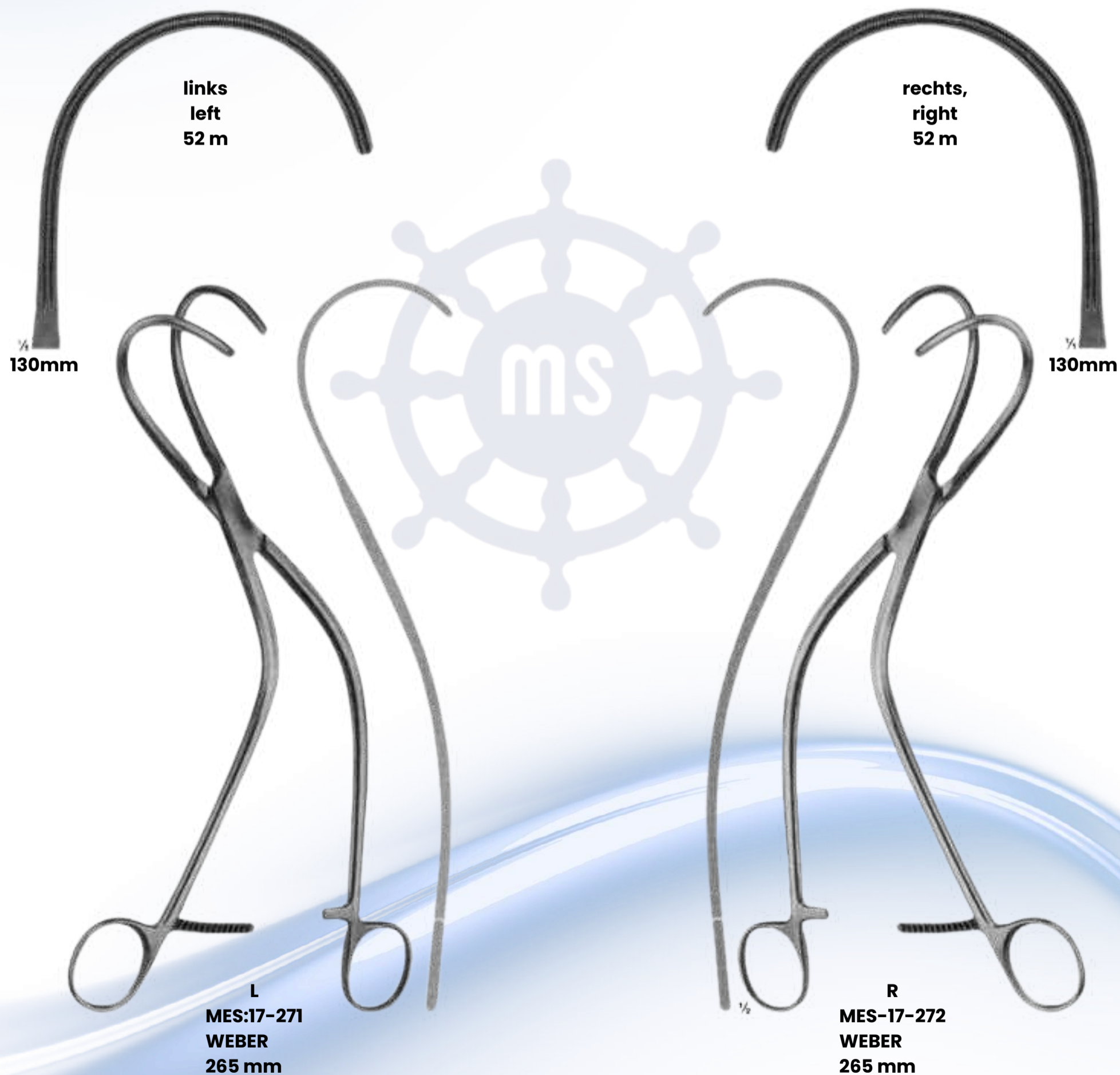

[Back to index](#)

## Aorta-Anastomosis Clamps



**MES-17-273 - 276**  
**DE BAKEY**



**MES-17-273    MES-17-274    MES-17-275    MES-17-276**

<b>Total Length:</b>	<b>230 mm</b>	<b>280mm</b>	<b>305 mm</b>	<b>240 mm</b>
<b>Length of jaws:</b>	<b>85 mm</b>	<b>100 mm</b>	<b>135 mm</b>	<b>93 mm</b>



**MES-17-277 - 280**  
**DE BAKEY**

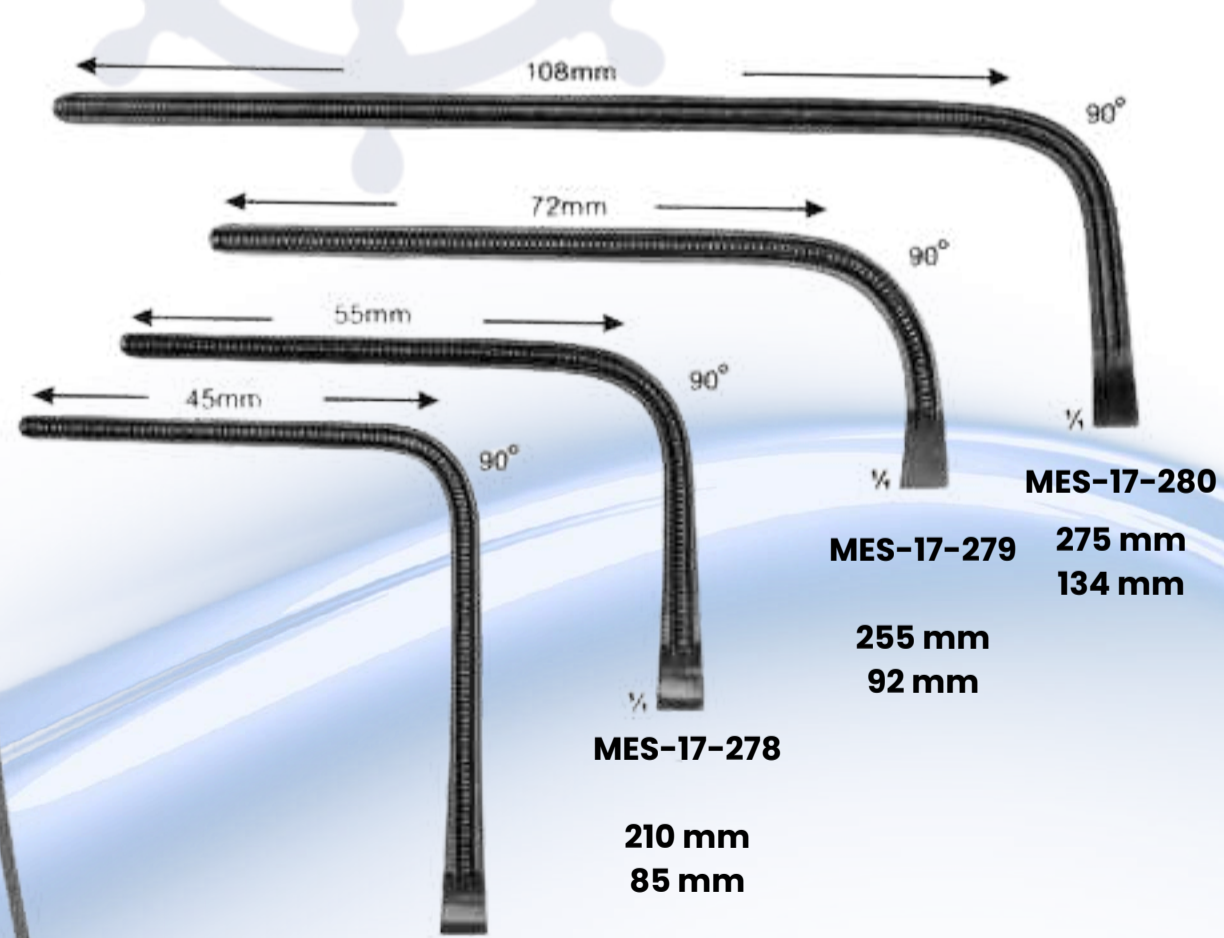

**MES-17-278    MES-17-279    MES-17-280**

<b>Total Length:</b>	<b>225 mm</b>
<b>Length of jaws:</b>	<b>93 mm</b>

**210 mm**  
**85 mm**

**255 mm**  
**92 mm**

**275 mm**  
**134 mm**

[Back to index](#)

## Aorta-Anastomosis Clamps



MES-17-281  
50mm



MES-17-282  
50mm

**MES-17-281 - 282**  
**COOLEY**  
 125 mm, 115 mm

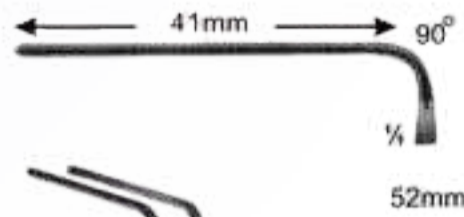

**MES-17-283**  
**COOLEY**  
 100 mm

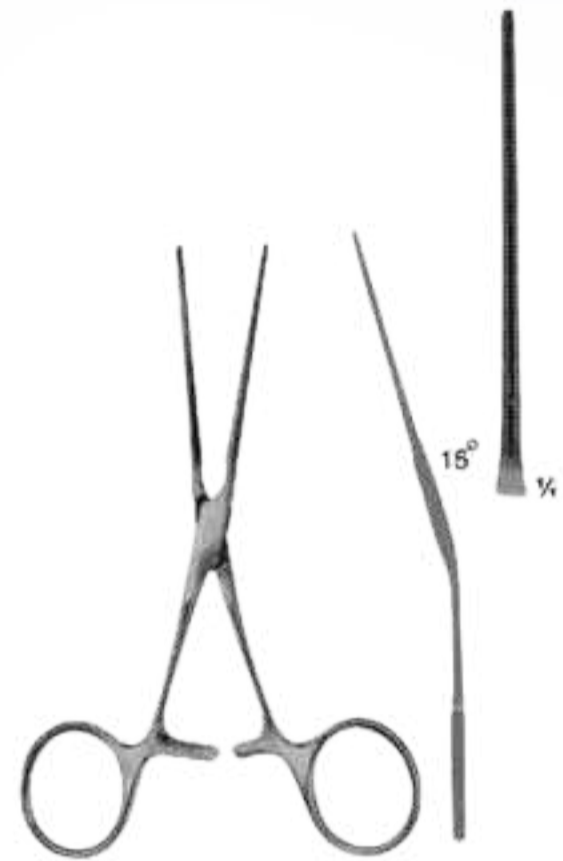

**MES-17-284**  
**COOLEY**  
 125 mm

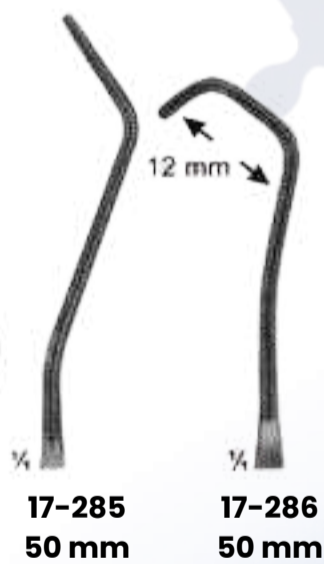
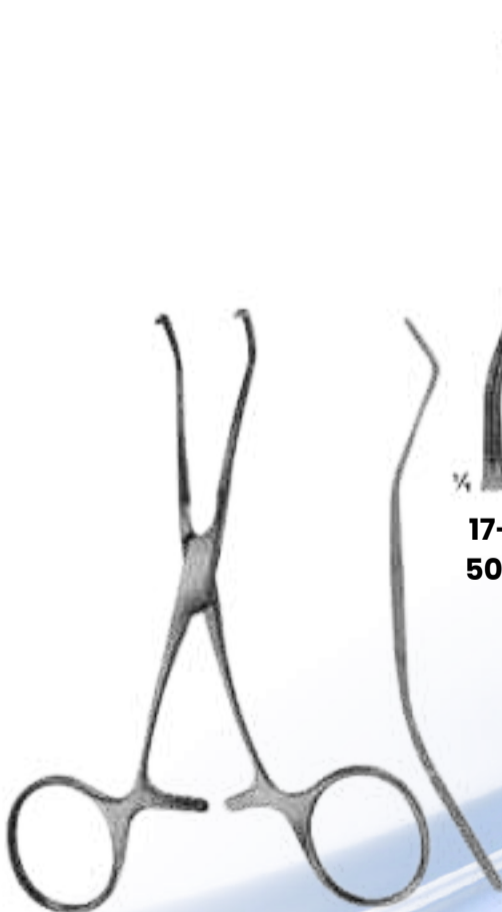

17-285  
50 mm

17-286  
50 mm

**MES-17-285 - 286**  
**COOLEY**  
 120 mm, 115 mm

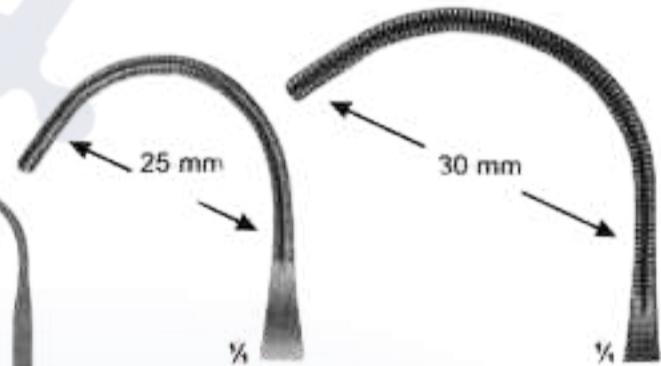

**MES-17-287**  
 56mm

**MES-17-288**  
 63 mm

**MES-17-287 - 288**  
**COOLEY-BACK**  
 150 mm, 115 mm

## Aorta-Anastomosis Clamps

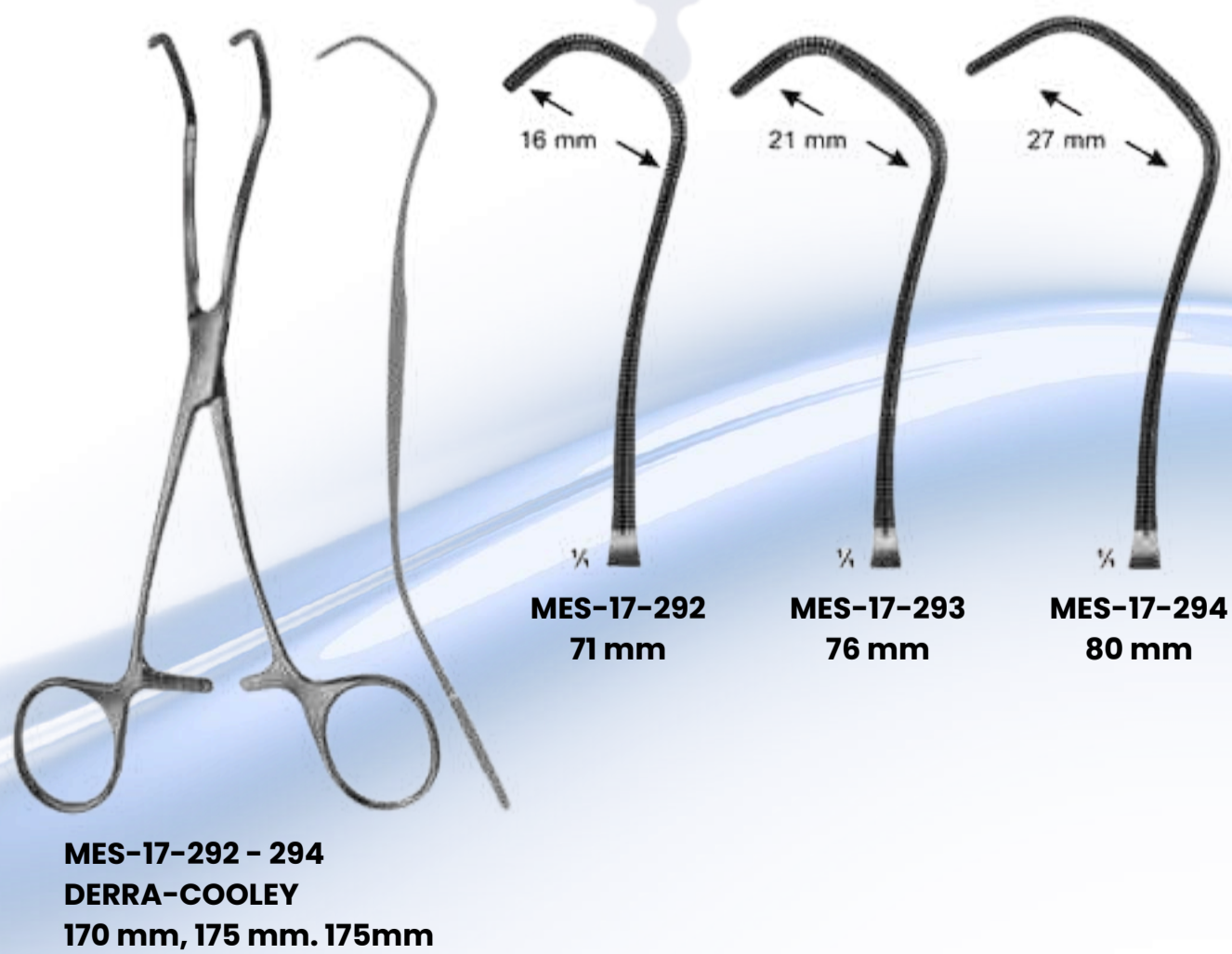
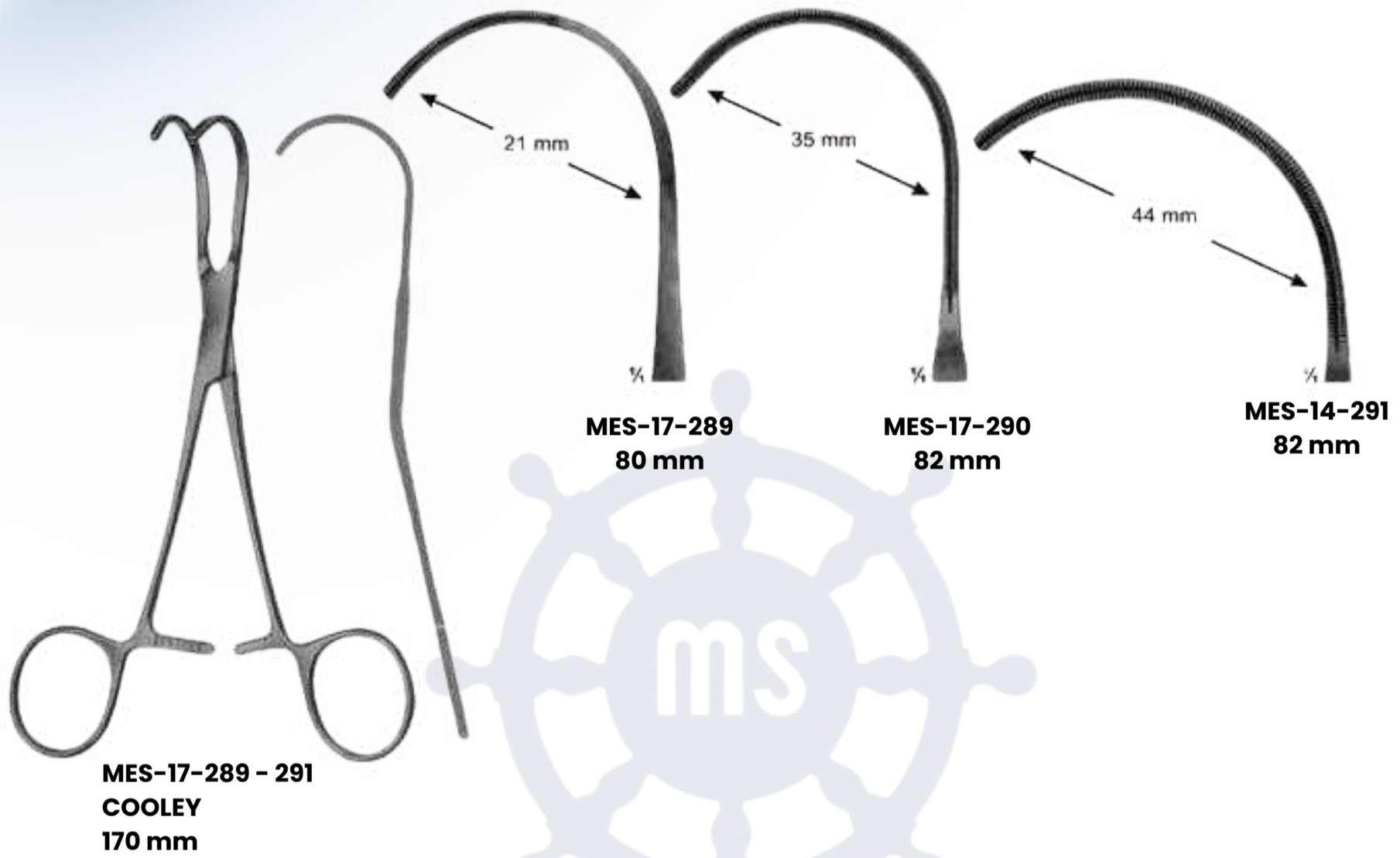

[Back to index](#)

## Aorta-Anastomosis Clamps



**MES-17-295 - 298**  
**COOLEY**  
 165 mm. 165 mm  
 175 mm. 180 mm

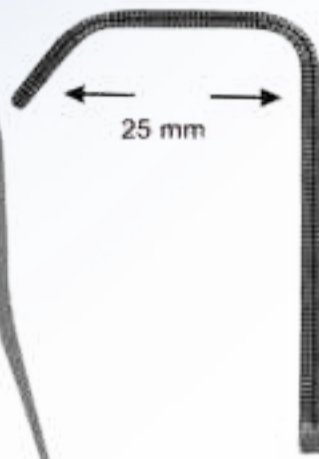

**MES-17-295**  
 72 mm



**MES-17-296**  
 76 mm



**MES-17-297**  
 72 mm

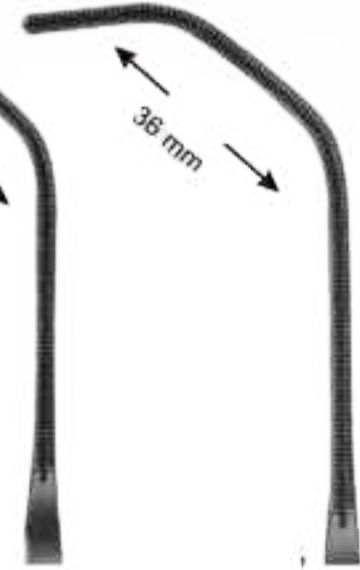

**MES-17-298**  
 76 mm



**MES-17-299**  
**COOLEY**  
 170 mm



**MES-17-300**  
**COOLEY**  
 175 mm



## Aorta-Anastomosis Clamps



**MES-17-301 - 302  
COOLEY**



**MES-17-301**  
 74 mm  
 185 mm  
**MES-17-302**  
 86 mm  
 195 mm



**MES-17-303  
COOLEY  
260mm**

108 mm



**17-304 - 306  
COOLEY**

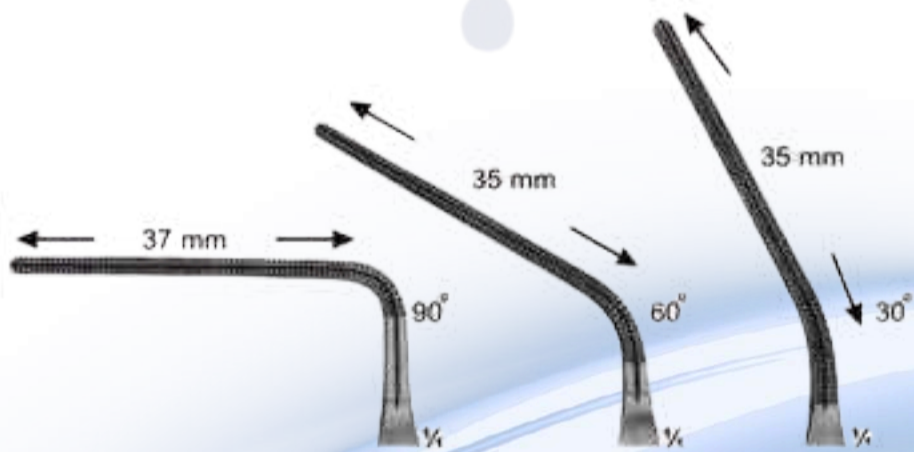

**MES-17-304  
150 mm**

**MES-14-305  
160 mm**

**MES-14-306  
165 mm**

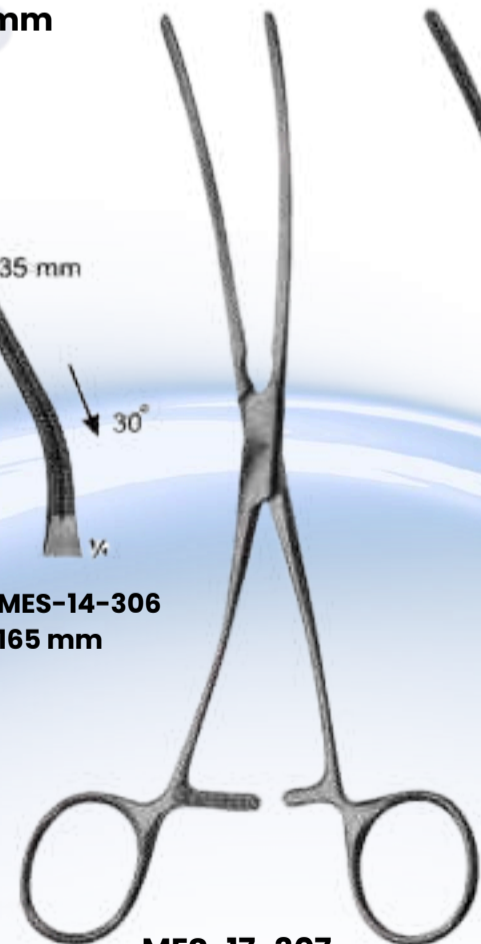

**MES-17-307  
COOLEY  
190 mm**

76 mm

## Aorta-Anastomosis Clamps

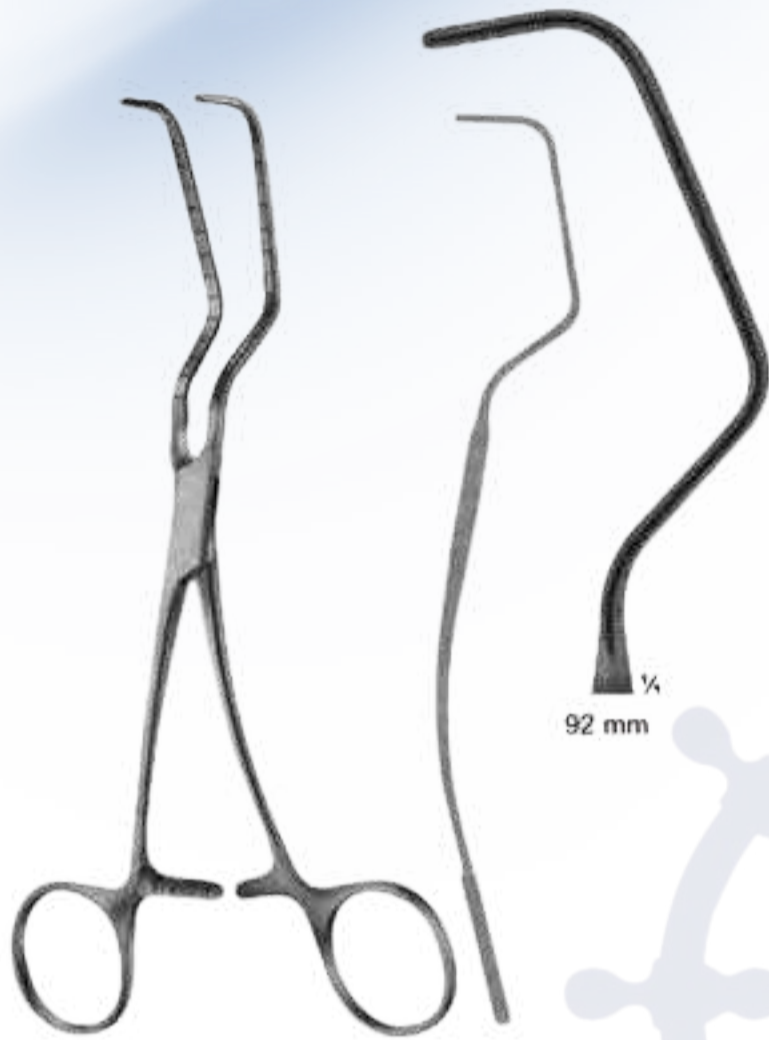

**MES-17-308**  
**PARRY-COOLEY**  
 185 mm

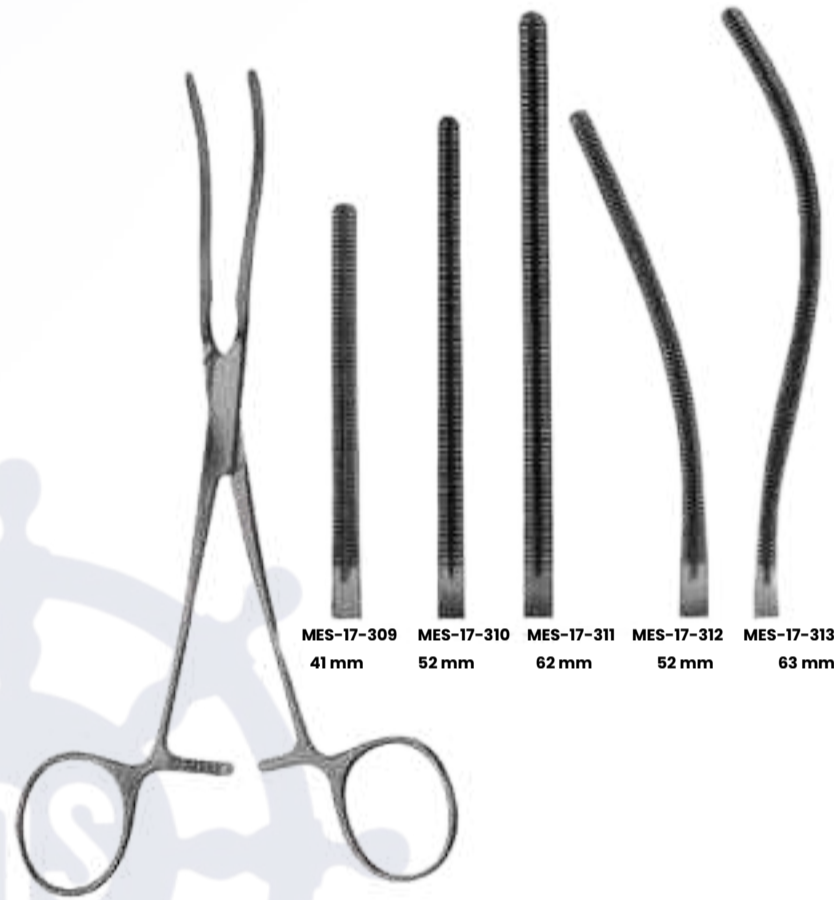

**MES-17-309 - 313**  
**COOLEY**  
 160 mm, 170 mm, 180 mm



**MES-17-314 - 317**  
 165 mm, 170 mm,  
 185mm , 185mm

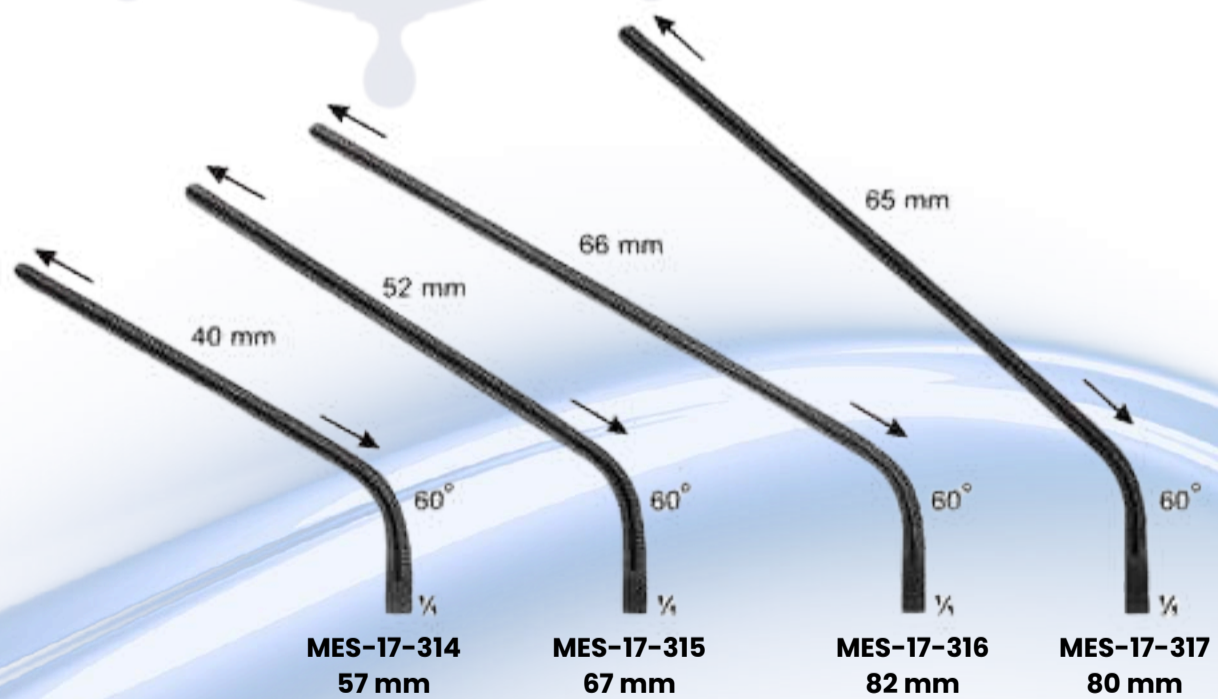

## Ring Handle Bulldog Clamps

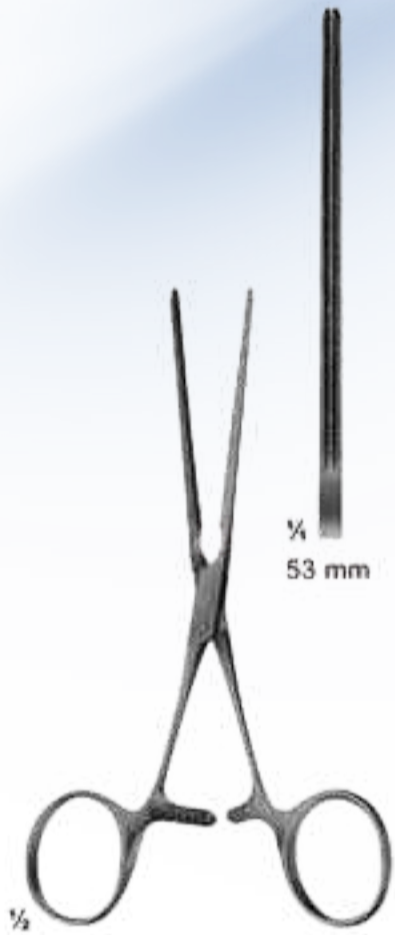

**MES-17-170**  
**DE-BAKEY**  
 gerade straight  
 130 mm



**MES-17-171**  
**DE-BAKEY**  
 Maul gebogen  
 curved jaws  
 125 mm

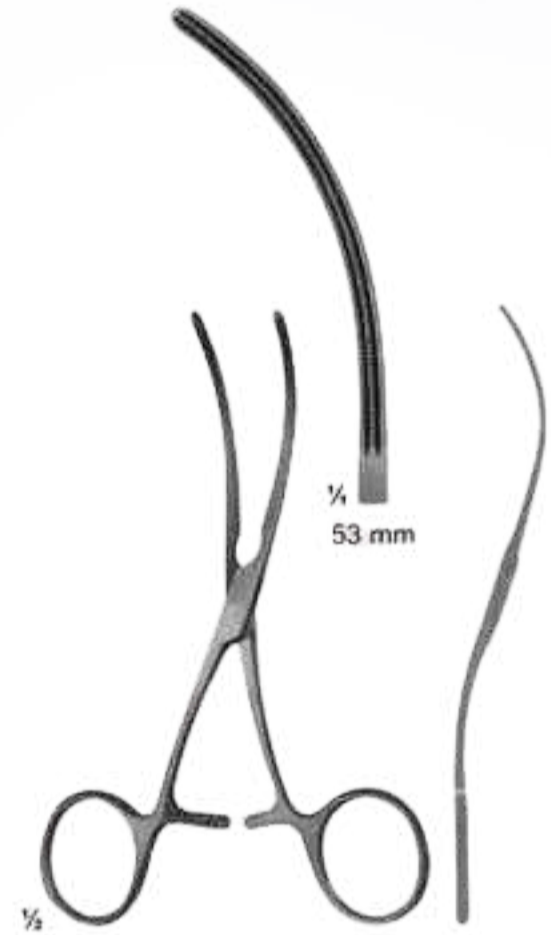

**MES-17-172**  
**DE-BAKEY**  
 S-shaped curved  
 125 mm

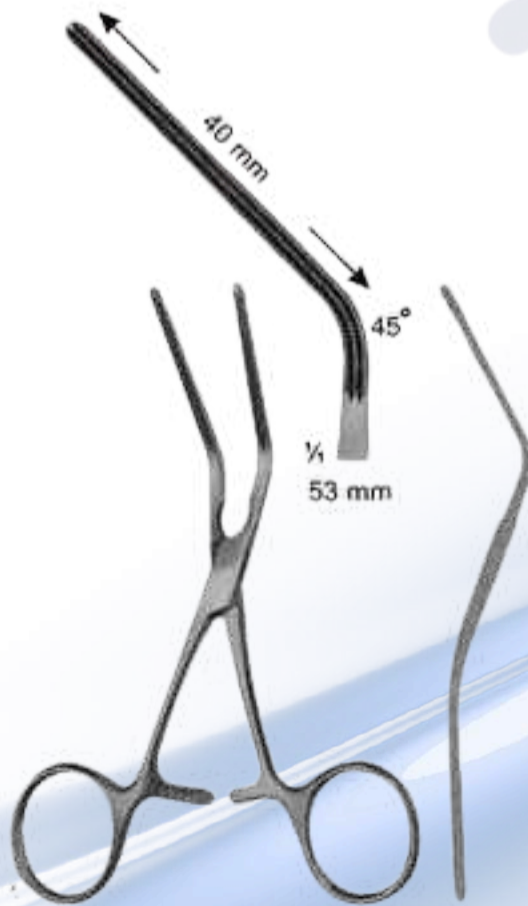

**MES-17-173**  
**DE-BAKEY**  
 45 winklig gebogen  
 angled 45°  
 125 mm



**MES-17-174**  
**DE-BAKEY**  
 90 winklig gebogen  
 angled 90°  
 105 mm

## Vena-Cava Clamps

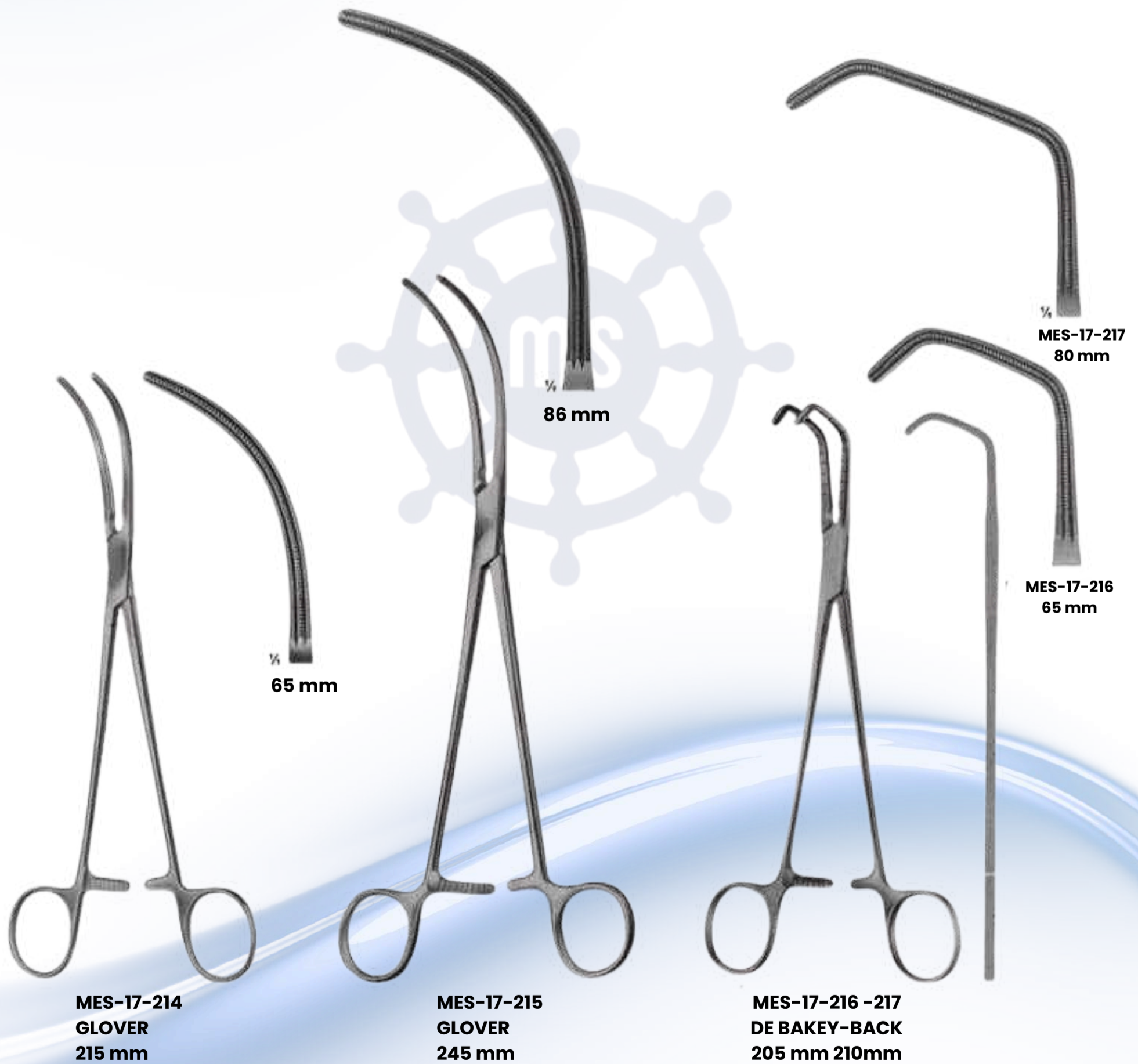

## Vena-Cava Clamps



**MES-17-218**  
86 mm

**MES-17-219**  
86 mm

**MES-17-220**  
86 mm

**MES-17-221**  
86 mm

**MES-17-218 - 221**  
**DE BAKEY-HARKEN**

MES-17-218-255 mm  
MES-17-219 - 245 mm  
MES-17-220 - 245 mm  
MES-17-221 - 245 mm

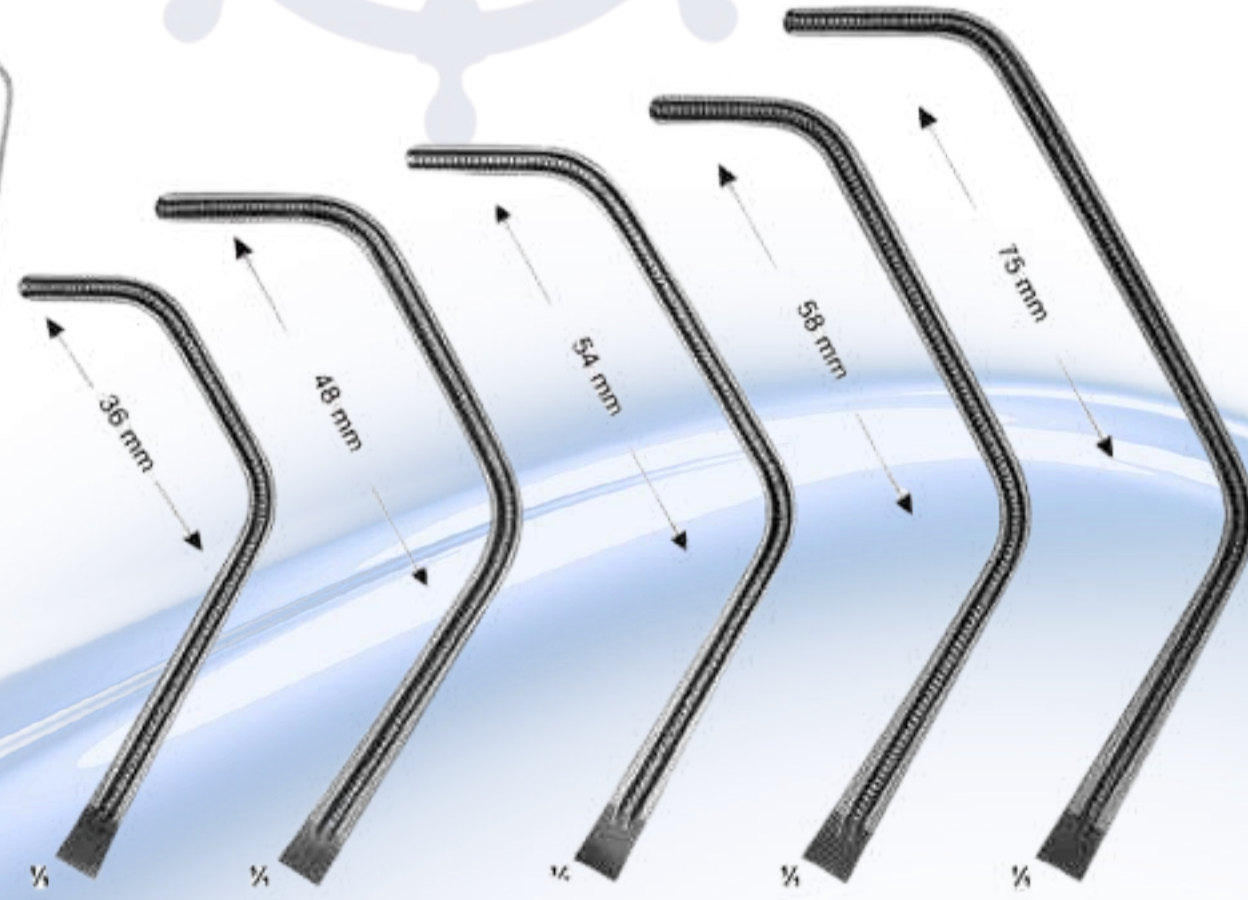

**MES-17-222 - 226**  
**DE BAKEY**

**MES-17-222**

**MES-17-223**

**MES-17-224**

**MES-17-225**

**MES-17-226**

**Total Length:**

220 mm

256 mm

270 mm

270 mm

280 mm

**Length of jaws:**

85 mm

95 mm

99 mm

103 mm

119 mm

[Back to index](#)

## Vena-Cava Clamps



**MES-17-227**  
68 mm

**MES-17-228**  
76 mm

**MES-17-229**  
84 mm

**MES-17-227 - 229**  
**DE BAKY-SATINSKY**  
235 mm, 240 mm, 245 mm



**MES-17-230**  
50 mm

**MES-17-231**  
50 mm

50 mm

**MES-17-230 - 231**  
**DE BAKY**  
170 mm, 165 mm

**MES-17-232**  
**DE BAKY**  
165 mm

[Back to index](#)

## Vena-Cava Clamps



**MES-17-233 - 235**  
**DE BAKEY**  
 205 mm, 225 mm, 240 mm



**MES-17-233** 41mm  
**MES-17-234** 65 mm  
**MES-17-235** 80 mm

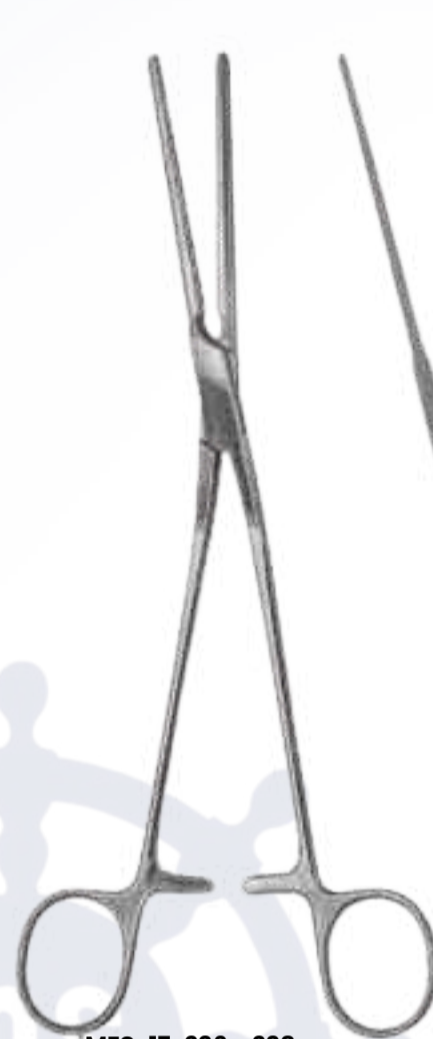

**MES-17-236 - 238**  
**DE BAKEY**  
 200 mm, 225 mm, 240 mm



**MES-17-236** 41mm  
**MES-17-237** 65 mm  
**MES-17-238** 80 mm



**MES-17-239**  
**DE BAKEY**  
 210 mm



**MES-17-240**  
**DE BAKEY**  
 210 mm



**MES-17-241**  
**DE BAKEY**  
 160 mm



## Vena-Cava Clamps



**MES-17-242**  
**DE BAKEY**  
**190 mm**



**MES-17-243**  
**DE BAKEY**  
**200 mm**



**MES-17-244**  
**DE BAKEY**  
**180 mm**



**MES-17-245 - 246**  
**DE BAKEY**  
**190 mm**

**MES-17-245**  
**77 mm**

**MES-17-246**  
**77 mm**

## Vena-Cava Clamps



**MES-17-247**  
**LELAND-JONES**  
195 mm

77 mm



**MES-17-248**  
**DE BAKEY**  
200 mm

liac clamp



**MES-17-249**  
**WERTHEIM**  
250 mm

67mm

## Vena-Cava Clamps

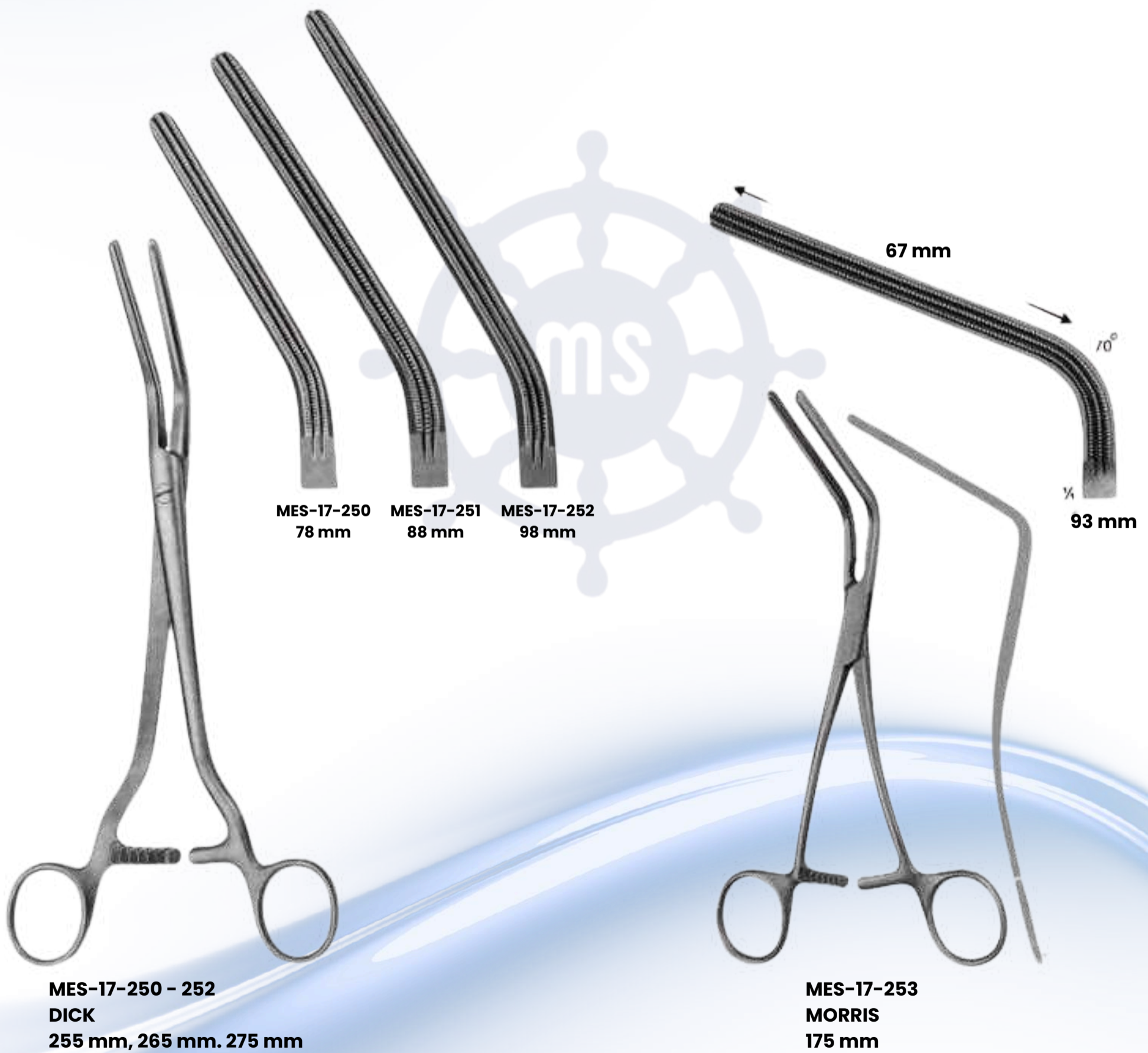

## Vena-Cava Clamps

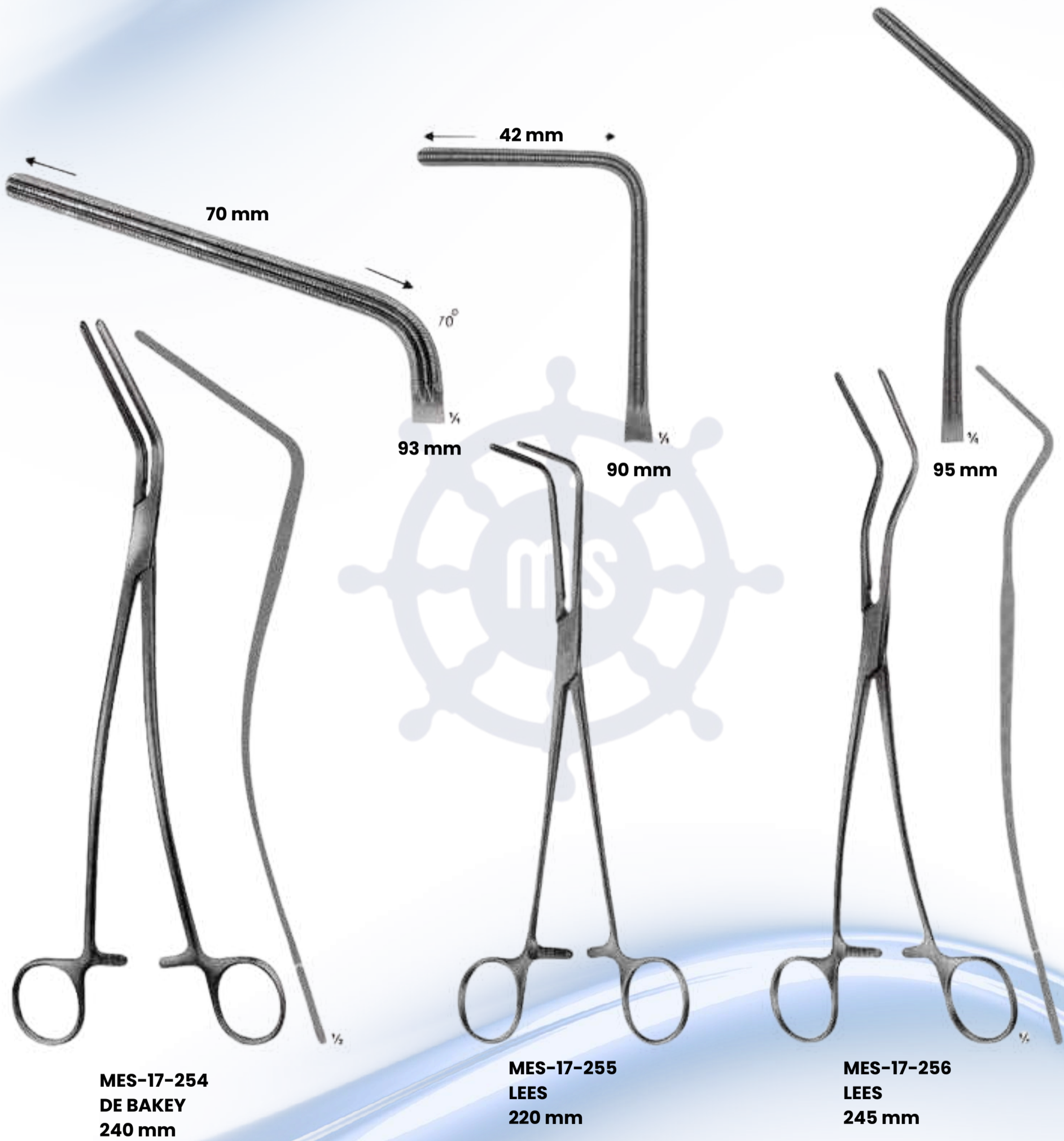

## Vena-Cava Clamps

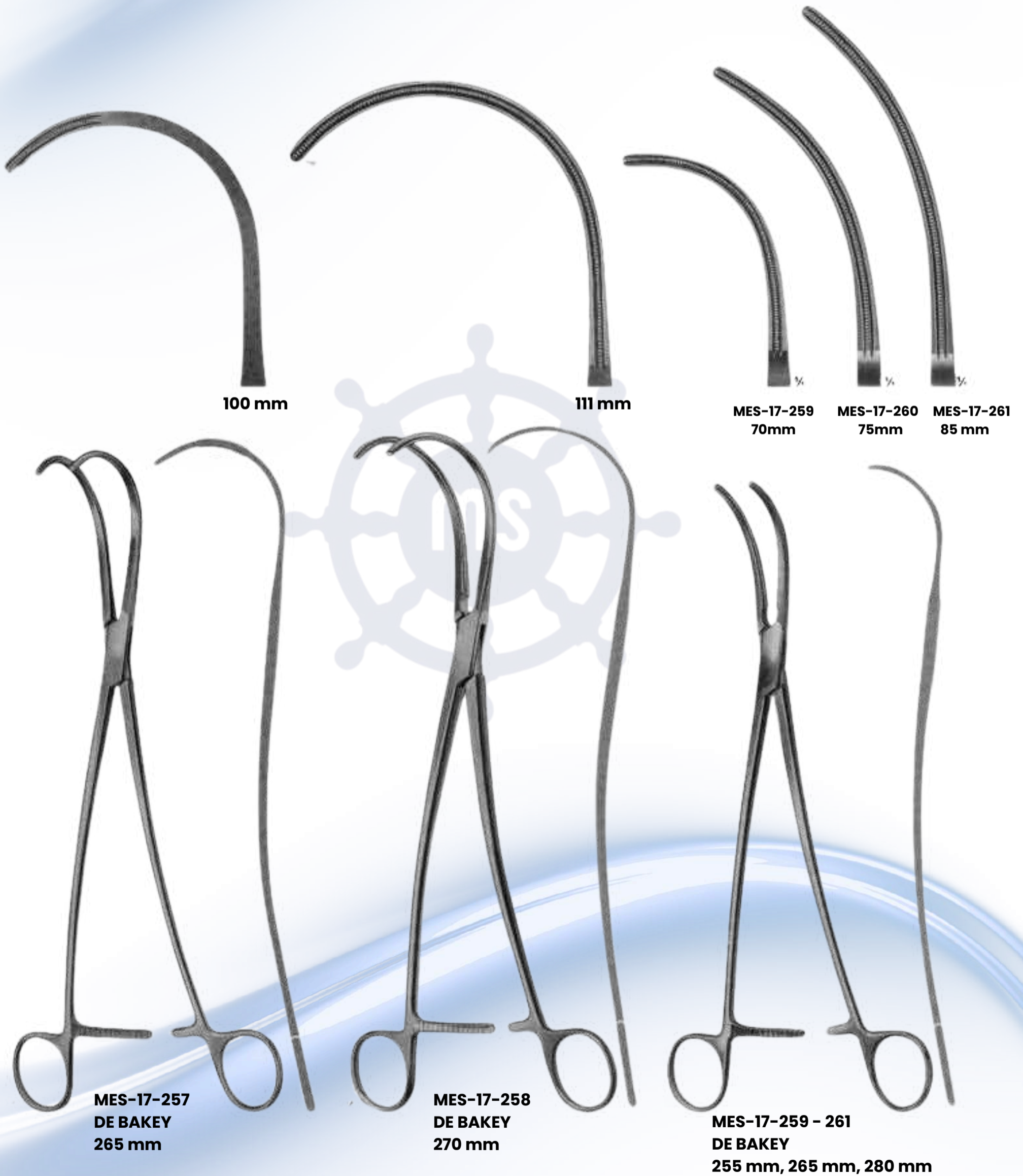

[Back to index](#)

## Vena-Cava Clamps

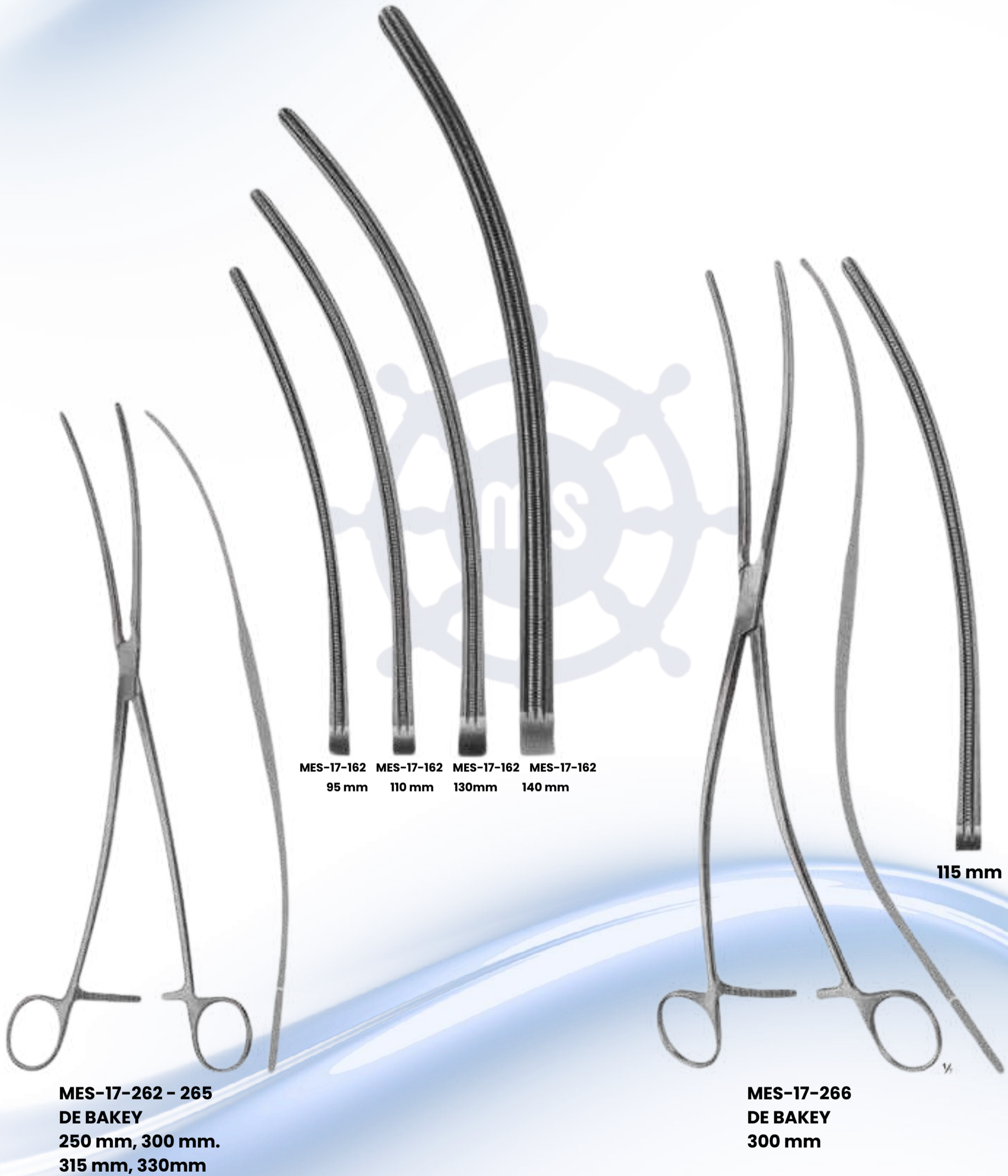

MES-17-162 MES-17-162 MES-17-162 MES-17-162  
 95 mm 110 mm 130mm 140 mm

115 mm

**MES-17-262 - 265**  
**DE BAKEY**  
 250 mm, 300 mm.  
 315 mm, 330mm

**MES-17-266**  
**DE BAKEY**  
 300 mm

## Vena-Cava Clamps

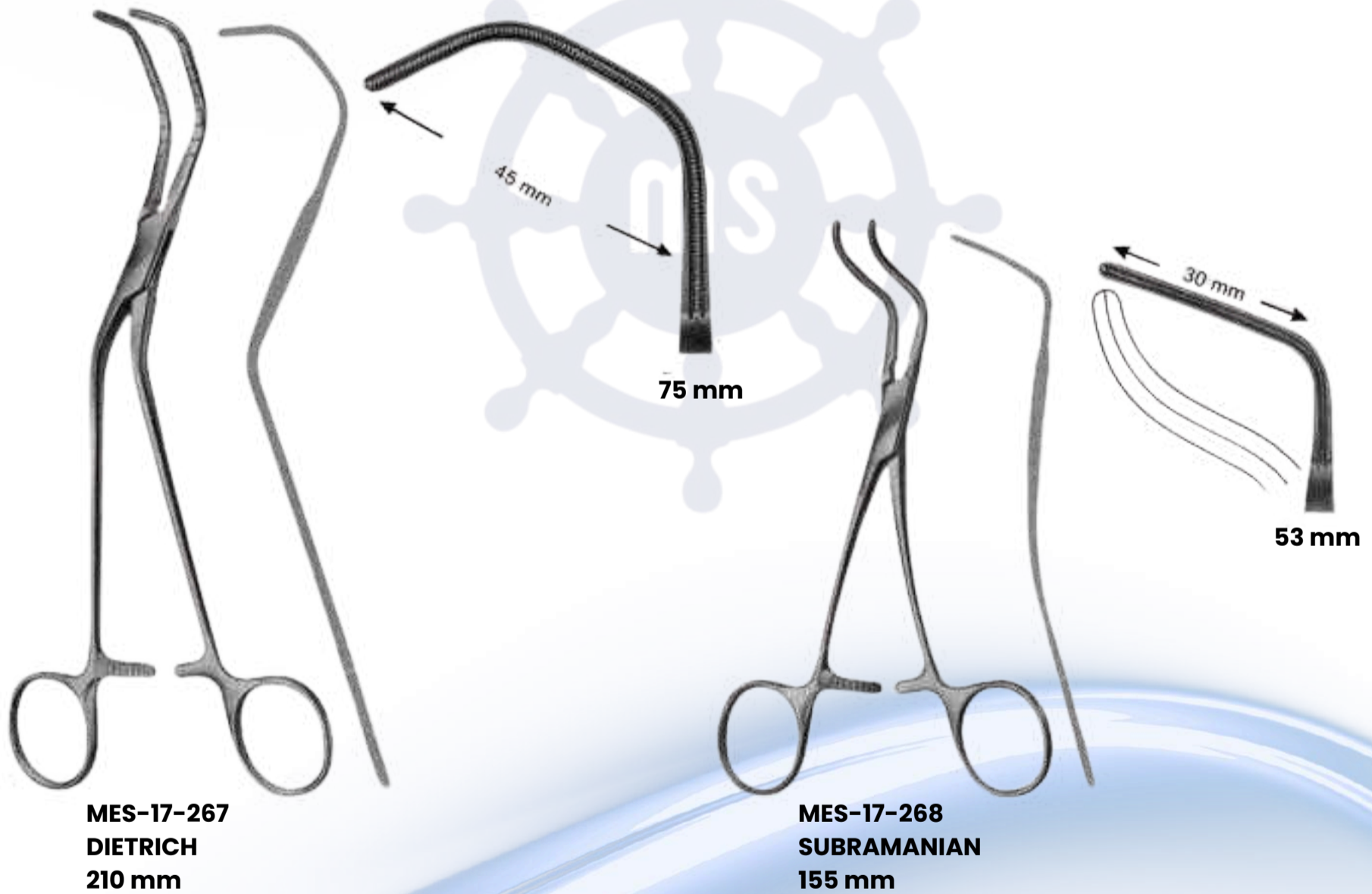

## Vena-Cava Clamps

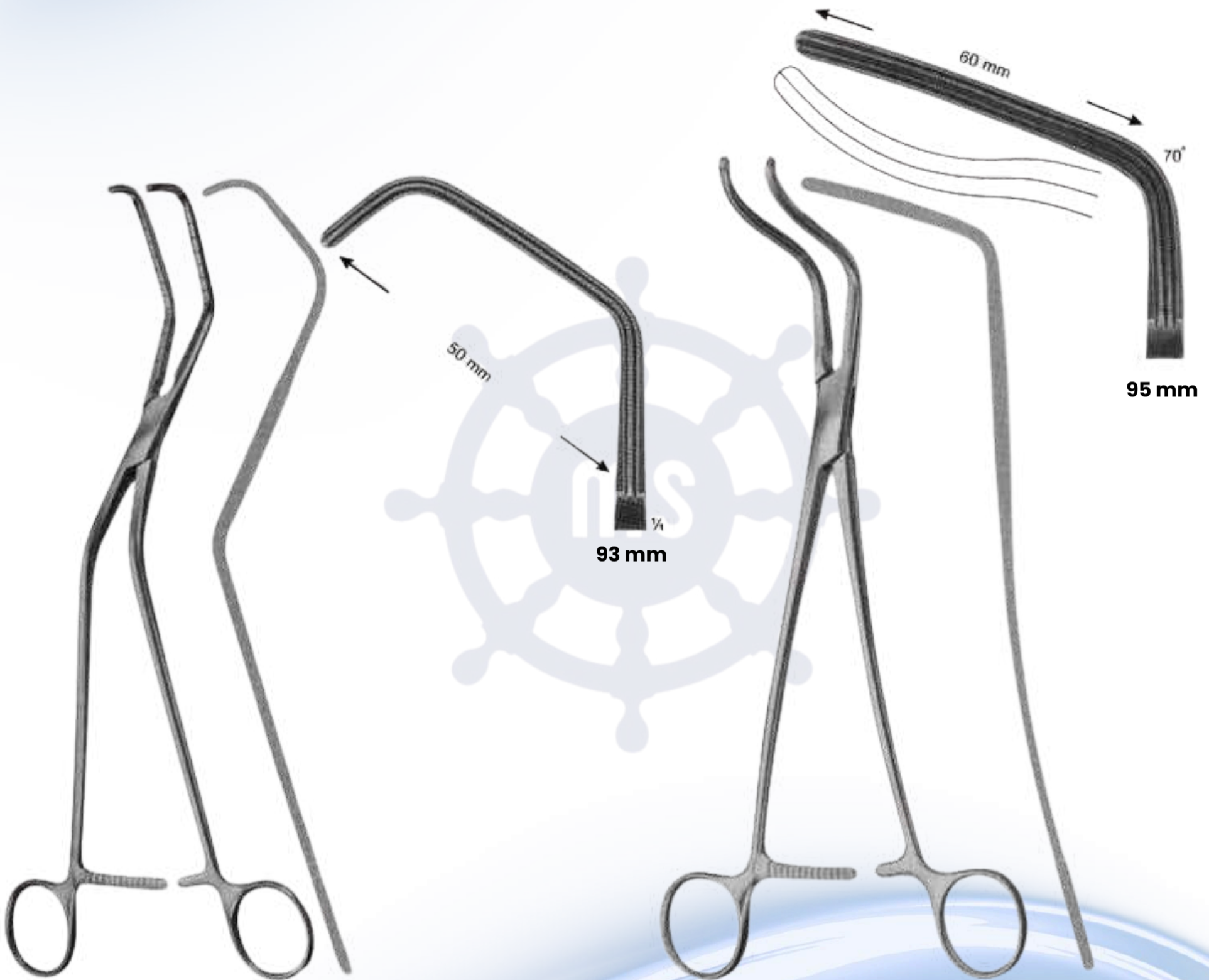

**MES-17-269**  
**OCHSNER**  
**260 mm**

**MES-17-270**  
**DE BAKEY**  
**265 mm**