



شركة الخدمات البحرية المحدودة
MARINE SERVICES CO., LTD.



Orthopedic & Bone Surgery Instruments

h

Precision • Quality • Reliability

Bone Cutting Instruments

1. Bone Cutting Forceps
2. Bone Rongeurs
3. Rongeurs
4. Punches

Bone Elevation Instruments

1. Elevators & Bone Levers
2. Bone Levers
3. Special Bone Levers

Bone Handling Instruments

1. Bone Holding Forceps
2. Bone Clamps
3. Reposition Forceps

Bone Shaping Instruments

1. Osteotomes
2. Chisels
3. Gouges

Bone Preparation Instruments

1. Bone Curettes
2. Bone Files & Rasps

Amputation Instruments

1. Amputation Knives
2. Amputation Retractors
3. Amputation Saws

ISO 13485 AND CE

Manufactured & supplied in compliance with international medical standards.

Bone Cutting Forceps



MES-22-178
STAMM
 150 mm



MES- 22-179
KAZANJIAN
 185 mm



MES-22-180 - 183
LISTON



MES-22-184 - 186
LISTON



Bone Cutting Forceps



MES- 22-187
BOHLER
145 mm



MES- 22-188
RUSKIN-LISTON
190 mm



MES-22-189
RUSKIN-LISTON
190 mm

Bone Cutting Forceps



MES-22-190
LISTON
curved on flat
240 mm



MES-22-191
LISTON straight
280 mm

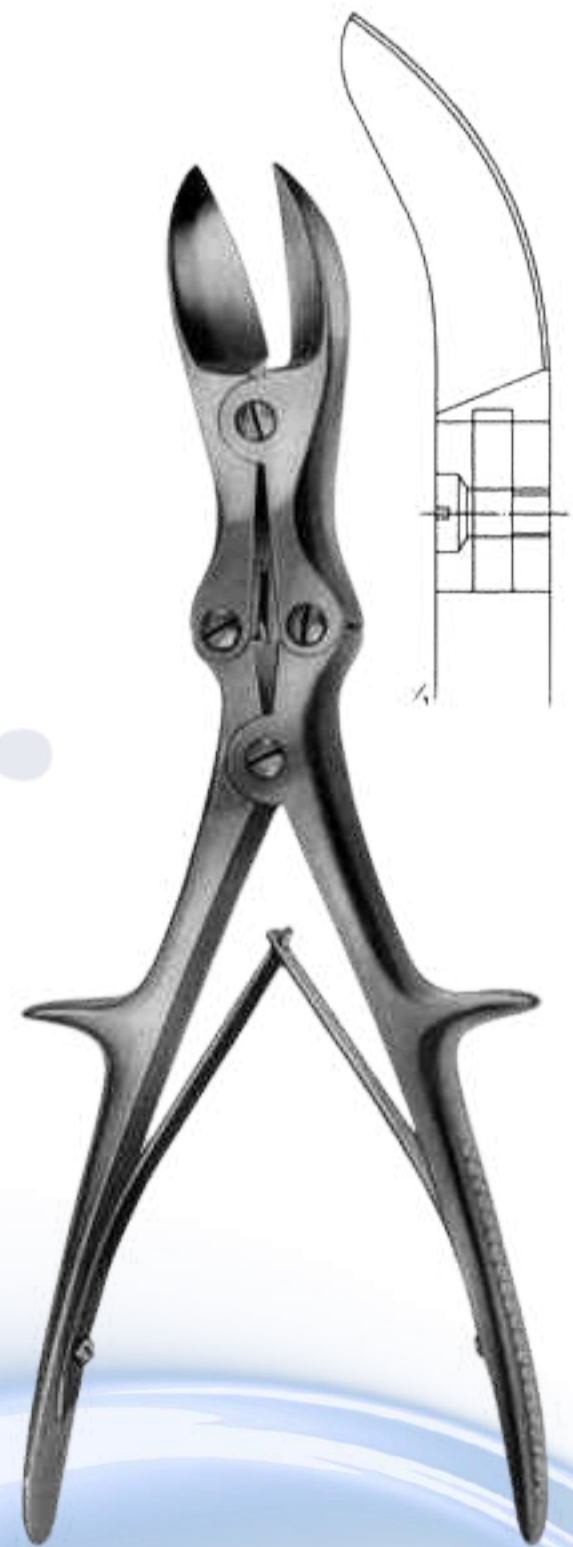

MES-22-192
LISTON
curved on flat
280 mm

Bone Cutting Forceps

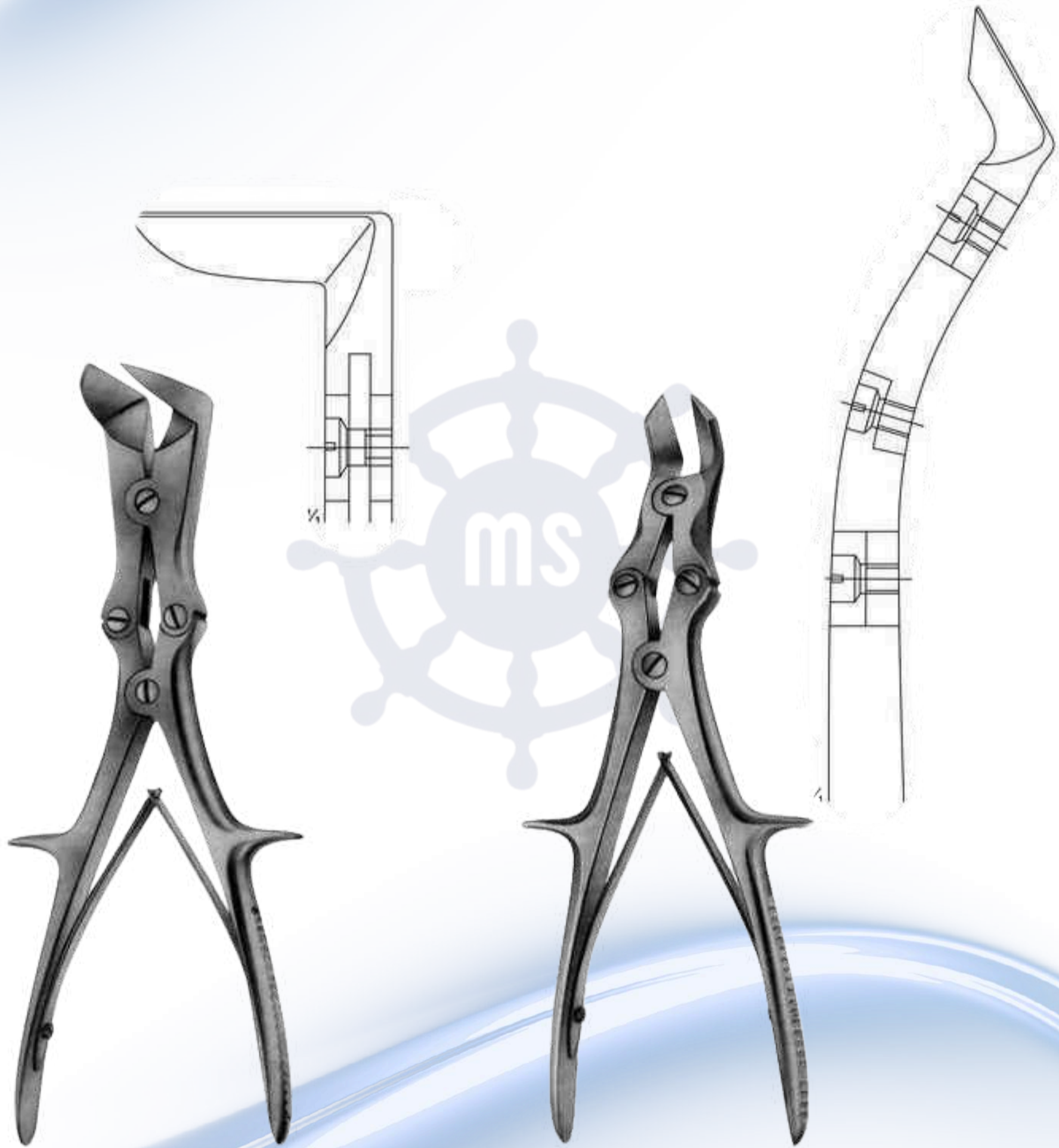

MES-22-193
LISTON-STILLE
265 mm

MES-22-194
LISTON-KEY-HORSLEY
(TUDOR EDWARDS)
255 mm

Synovectomy-Rongeurs, Bone Rongeurs



MES-22-137-138
Synovcetomy rongeur
 width of jaws 1.2 mm
 130 mm

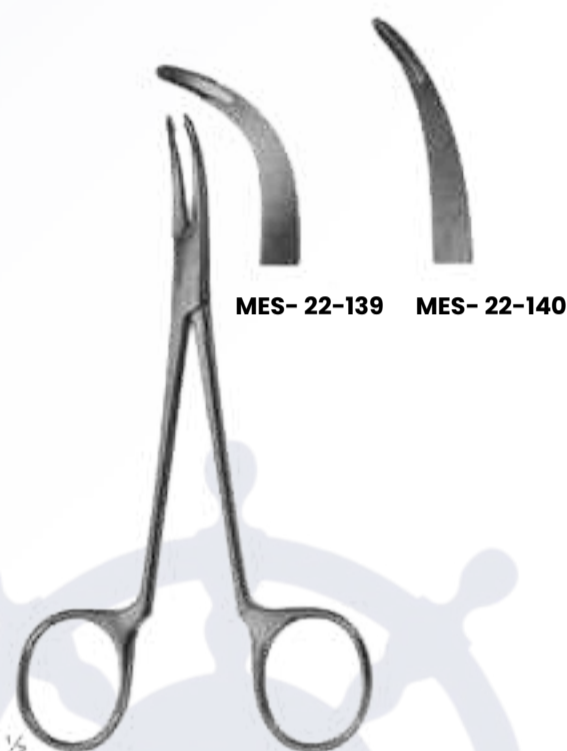

MES-22-139 - 140
Synovcetomy
rongeur width of jaws
 2.0 mm
 130 mm

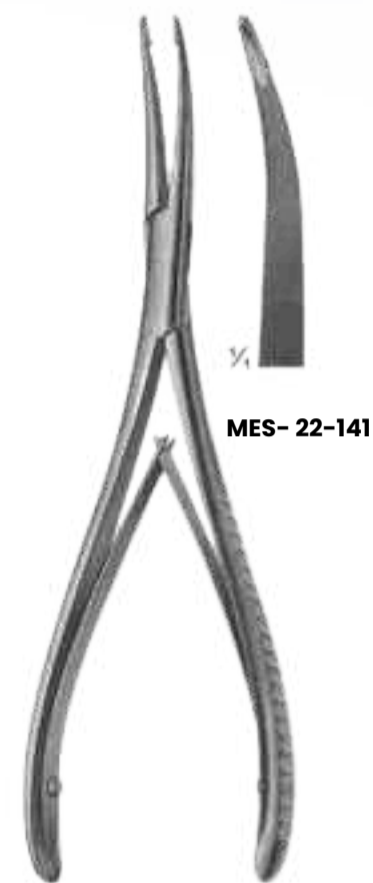

MES-22-141
STELLBRINK
Synovectomy
rongeur
 175 mm



MES-22-142
STELLBRINK
Synovectomy rongeur
 170 mm



MES-22-143
LURE-FRIEDMANN
 145 mm



MES-22-144
MARTIN
 205 mm

BIRCHER-GANSKE
 200 mm

BIRCHER-GANSKE
 200 mm

MARTIN
 205 mm

[Back to index](#)

Bone Rongeurs



MES-22-145
LURE
150 mm



MES-22-146
LURE
155 mm



MES-22-147
BLUMENTHAL
155 mm



MES-22-148
BLUMENTHAL
150 mm



MES-22-149 - 150
JANSEN
175 mm



MES-22-151
BANE-HARTMANN
175 mm

Bone Rongeurs



22-152
ALEXANDER
140 mm



22-153
JANSEN
190 mm



22-154- 155
LEMPERT
200 mm



22-156
BEYER
180 mm



22-157
MEAD
165 mm.



22-158
MEAD
165 mm

Bone Rongeurs



MES-22-159 - 160
LURE
175 mm



MES-22-161
LURE
180 mm



MES-22-162
LURE
180mm



MES- 22-163
OLIVECRONA
205 mm



MES- 22-164 - 165
BOHLER
155 mm



MES-22-166
MARQUARDT
200 mm

[Back to index](#)

Bone Rongeurs



MES-22-167
RUSKIN
190 mm



MES-22-168
ROTTGEN-RUSKIN
240 mm



MES-22-169 - 170
ECHLIN
230 mm

Bone Rongeurs



MES-22-171
STILLE
235 mm



MES-22-172
LEKSELL-STILLE
240mm



MES-22-173
STILLE-RUSKIN
240mm

Bone Rongeurs



MES-22-174
LURE-STILLE
225 mm



MES-22-175
LURE-STILLE
225 mm

Rongeurs

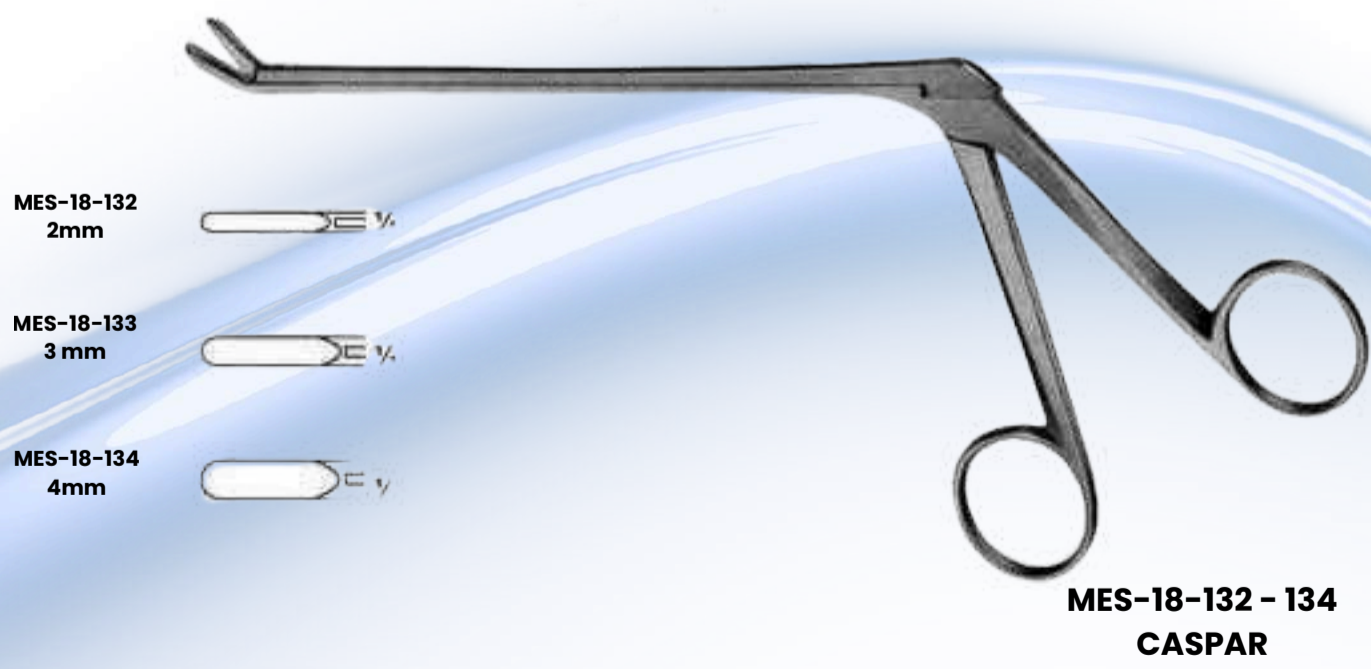
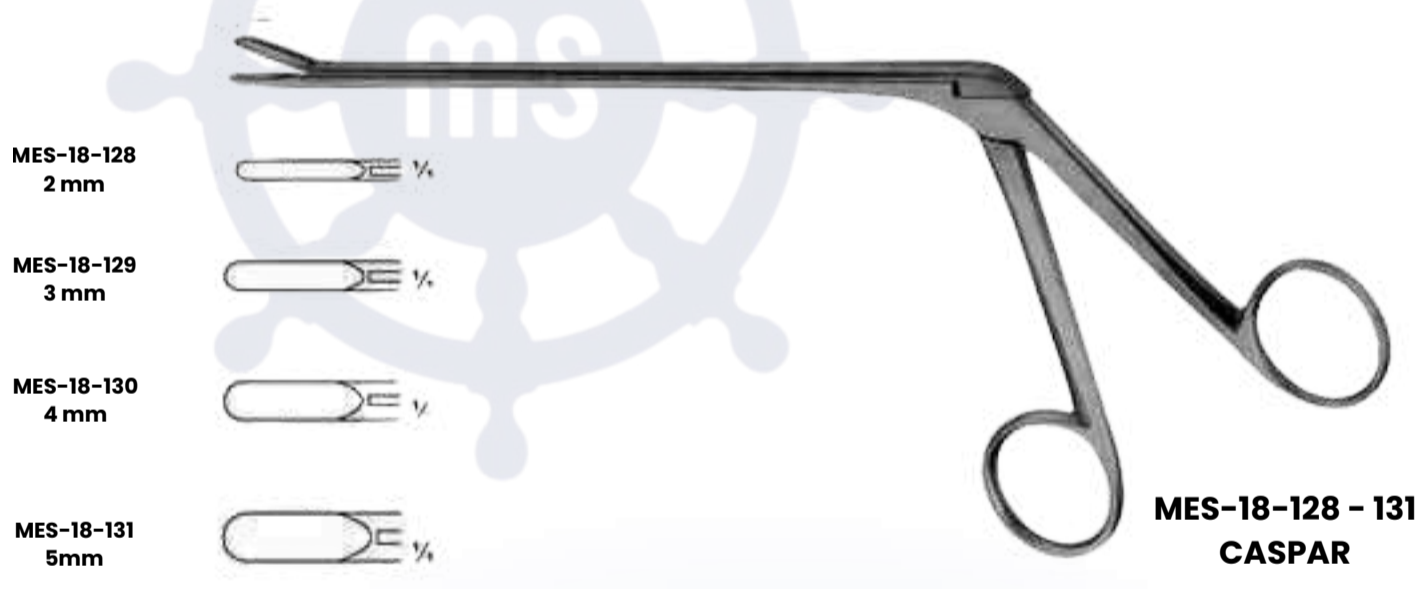

[Back to index](#)

Rongeurs

MES-18-135
2 mm



MES-18-136
3 mm



MES-18-137
4 mm

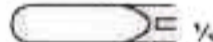

MES-18-135 - 137
CASPAR

Length of shaft
140 mm

Length of shaft
160 mm

Length of shaft
185mm

size of jaws

MES-18-138

MES-18-143

MES-18-148

2x12 mm



MES-18-139

MES-18-144

MES-18-149

3X12 mm



MES-18-140

MES-18-145

MES-18-150

4X14 mm



MES-18-141

MES-18-146

MES-18-151

5 X14 mm



MES-18-142

MES-18-147

MES-18-152

6X16 mm

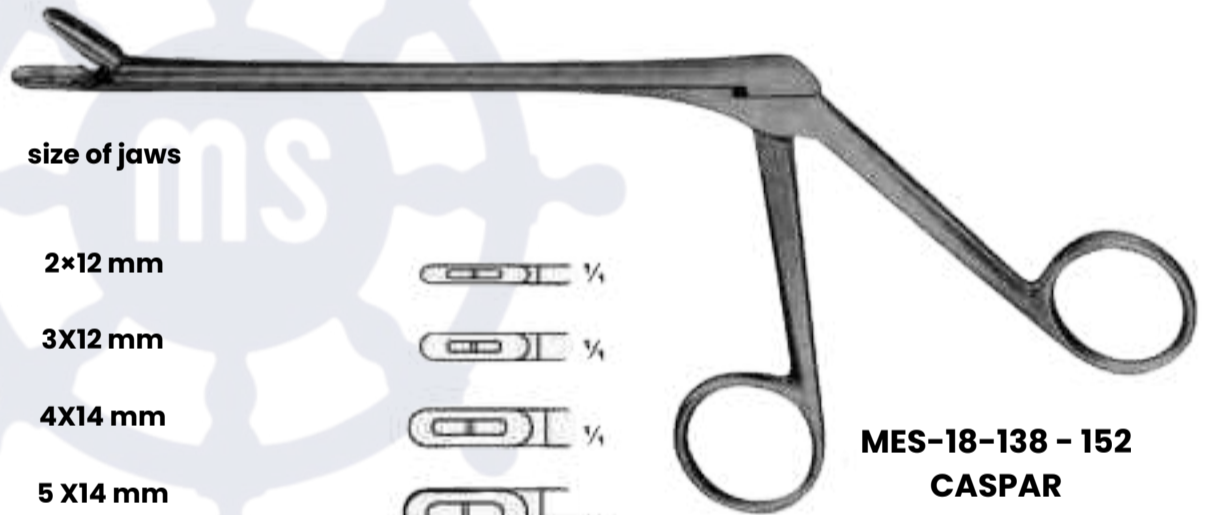

MES-18-138 - 152
CASPAR

Length of shaft
140 mm

Length of shaft
160 mm

Length of shaft
185mm

size of jaws

MES-18-153

MES- 18-156

MES-18-159

3x12 mm

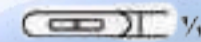

MES- 18-154

MES-18-157

MES-18-160

4X14 mm



MES-18-155

MES-18-158

MES-18-161

5X14 mm

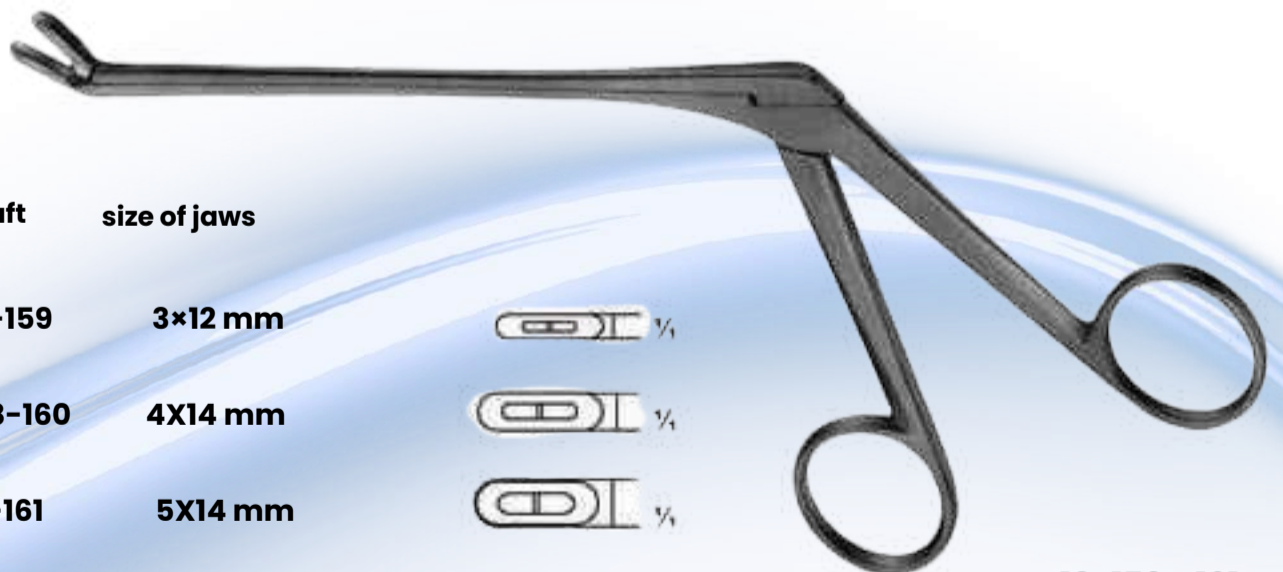

MES-18-153 - 161
CASPAR

Rongeurs

Length of shaft
140 mm

Length of shaft
160 mm

Length of shaft
185mm

size of jaws

MES-18-162

MES-18-164

MES-185-166

3X12 mm



MES-18-163

MES-18-165

MES-18-167

4 x14 mm



MES-18-168
2 X 10 mm
GUSHING

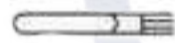

MES-18-169
3 X 10 mm
LOVE-GRUENWALD



MES-18-170
4 X 10 mm
SPURLING



MES · 18-171
3 x 10 mm
LOVE-GRUENWALD



MES-18-172
4 X 10 mm
SPURLING



Rongeurs

MES-18-173
3 × 10 mm
LOVE-GRUENWALD



MES-18-174
4 × 10 mm
SPURLING



MES-18-173 - 174
LOVE-GRUENWALD

MES-18-175
7 mm



MES-18-175
OLDBERG

MES-18-176
YASARGIL
2,2 mm

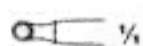

MES-18-177
YASARGIL
3,5 mm

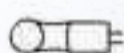

MES-18-176 - 177

Rongeurs

MES-18-178
4mm

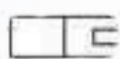

MES-18-178
CASPAR

MES-18-179
4 mm

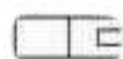

MES-18-179
CASPAR

MES-18-180
5,5 mm



MES-18-180
WAGNER

[Back to index](#)

Punches

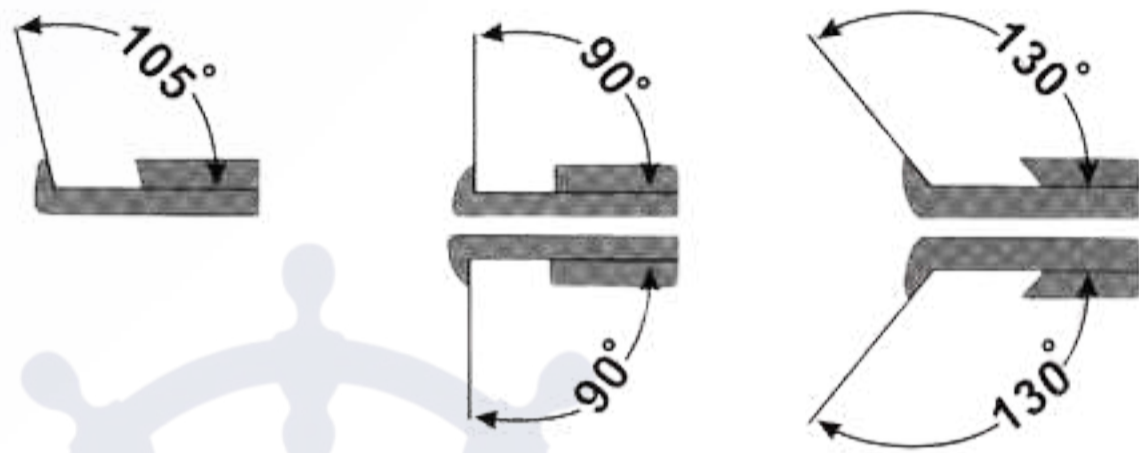

90° upwards cutting

65 mm

MES-18-101

MES-18-102

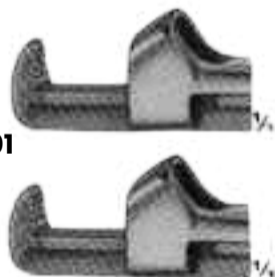

MES-18-101 - 102
CITELLI
 2 mm, 3,5 mm

90° upwards cutting

95 mm

MES-18-103
CITELLI- BEYER
 1,8 mm



Punches

90° upwards cutting

MES-18-104
4mm



MES-18-105
5 mm



MES-18-104 - 105
KERRISON



90° upwards cutting

MES-18-106
3,3 mm



MES-18-107
4,0 mm



MES-18-106 - 107
HAJEK-KOFLER

Punches

130° upwards cutting

MES-18-108
1 mm 

MES-18-109
2 mm 

MES-18-110
3 mm 

MES-18-111
4 mm 

MES-18-112
5 mm 

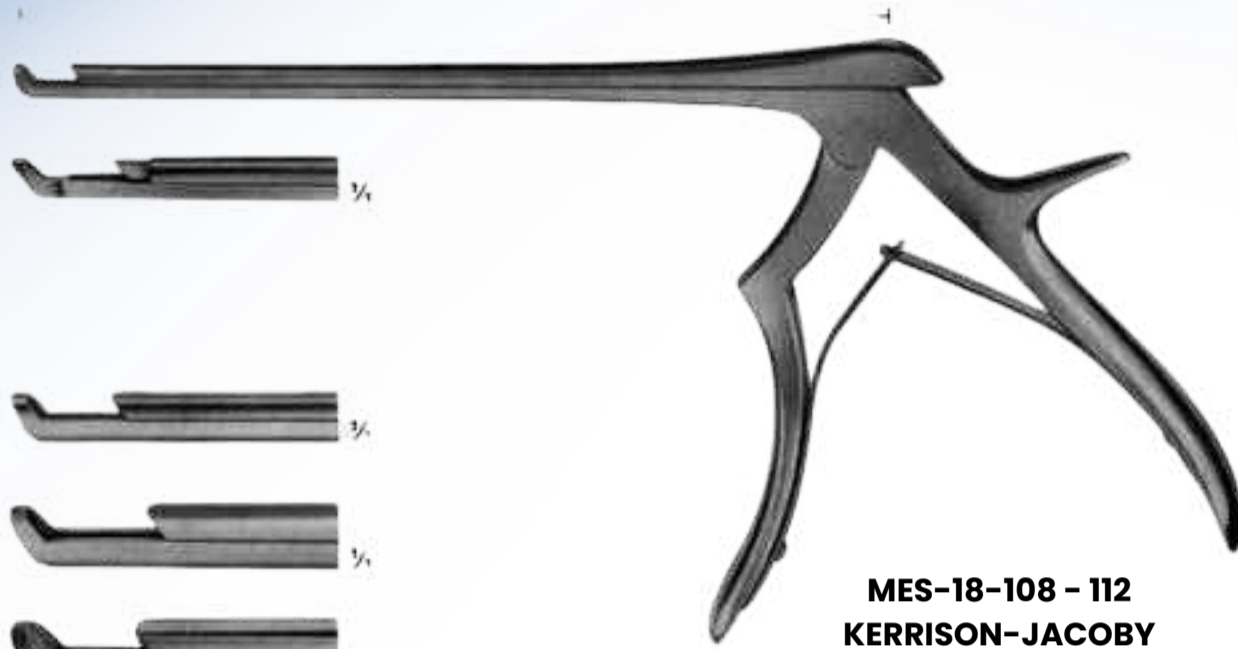

MES-18-108 - 112
KERRISON-JACOBY

90° upwards cutting

MES-18-113
1 mm 

MES-18-114
2 mm 

FERRIS-SMITH-KERRISON

MES-18-115
3 mm 

MES-18-116
4 mm 

MES-18-117
5 mm 

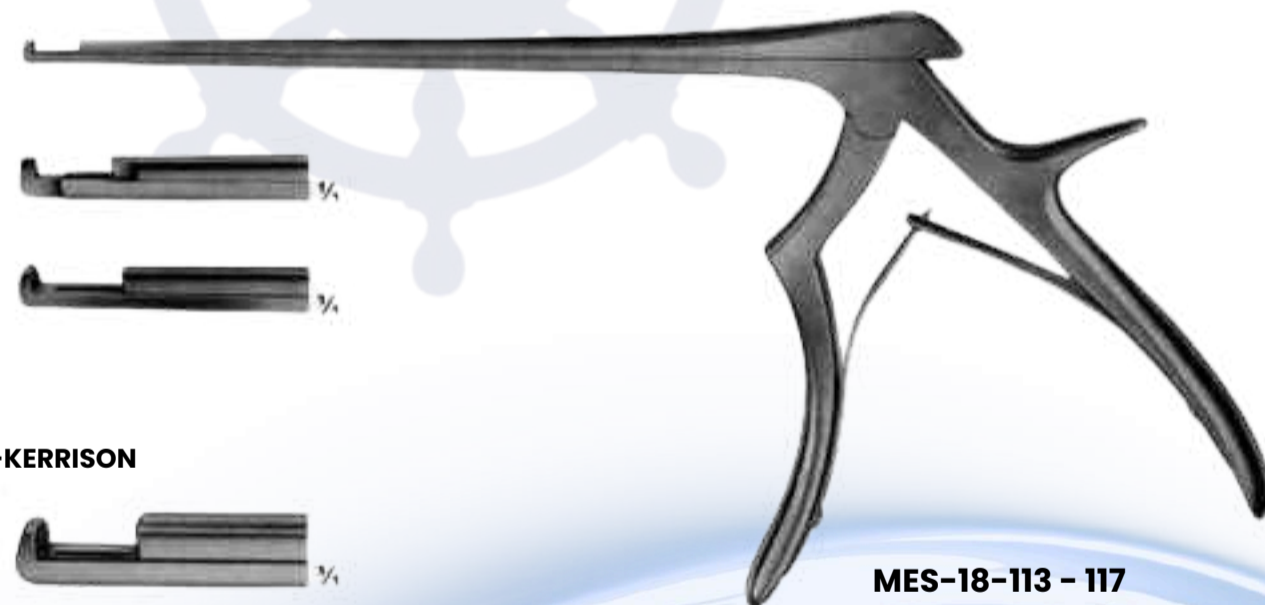

MES-18-113 - 117
KERRISON-JACOBY

Bone Clamps



MES-22-133 - 134
LOWMAN
MES-22-133 170mm
MES-22-134 205 mm



MES-22-135
LOWMAN-GERSTER
210 mm



MES-22-136
LOWMAN-HOGLUND
175 mm

Reposition Forceps



MES-22-101
 Reposition forceps.
 for small fragments
 135 mm



HAASE
MES-22-102
 Reposition forceps,
 for mandibular
 fractures
 165mm



REILL
MES-22-103
 Reposition forceps.
 170mm



MES-22-104
 Reposition forceps
 205 mm



MEYER
MES-22-105
 Reposition forceps for
 fingers, with drill guide for
 KIRSCHNER wires up to
 daim. 1.0 mm
 170mm

[Back to index](#)

Reposition Forceps, Bone Holding Forceps



MES-22-106
Patella forceps
185 mm



MES-22-107
Forceps with
ratchet fixation
140 mm



MES-22-108
Forceps with
thread fixation
170 mm

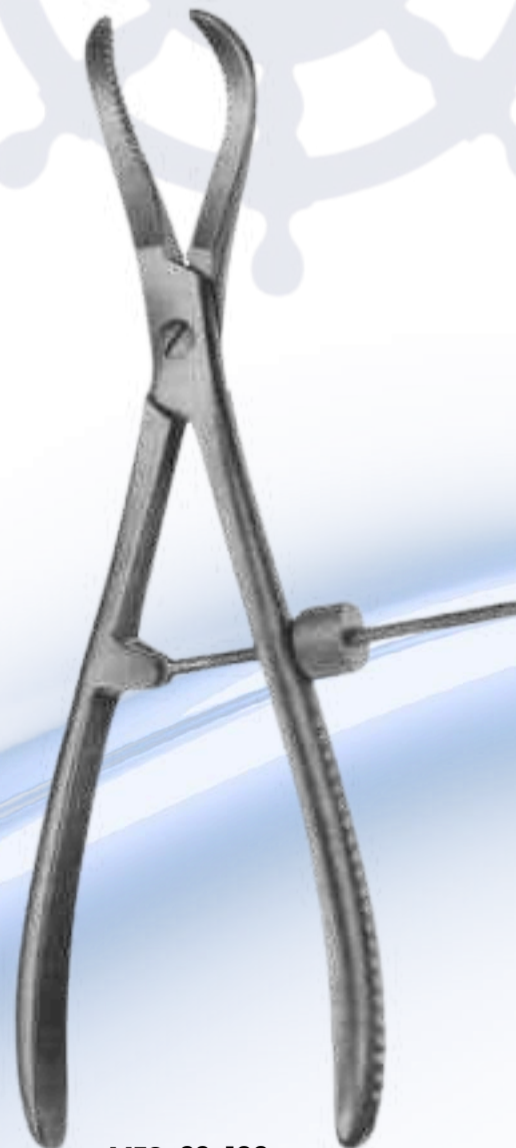

MES-22-109
Forceps with
thread fixation
235 mm



MES-22-110
DINGMANN
185 mm

[Back to index](#)

Bone Currettes



MES-20-233
JACOBSON
 140 mm



MES-20-234
MARTINI
 140 mm



MES-20-235
MARTINI
 140mm



MES-20-236
WILLIGER
 145 mm



MES-20-237
JANSEN
 160 mm



MES-20-238
BARTH
 180 mm



MES-20-239
VOLKMANN
 130 mm

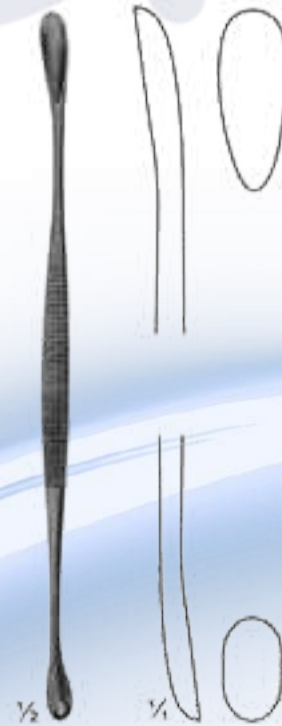

MES-20-240
VOLKMANN
 145 mm



MES-20-241
VOLKMANN
 170 mm

Bone Currettes



MES-20-242
JANSEN
160mm



MES-20-243
HEMINGWAY
170 mm



MES-20-244
HEMINGWAY
175 mm

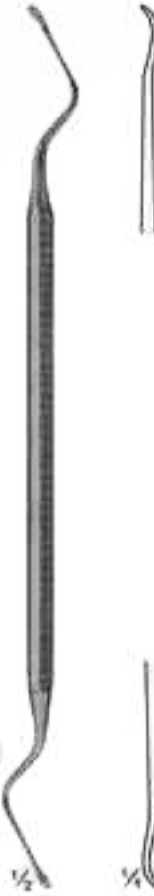

MES-20-245
LUCAS
180 mm

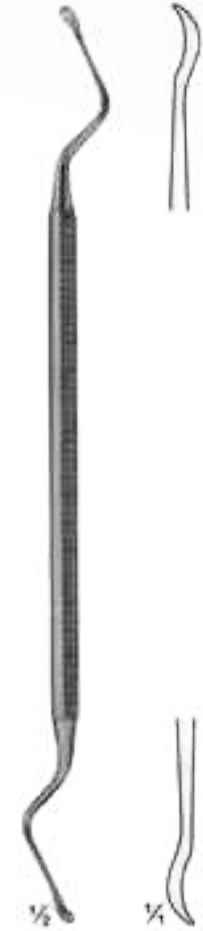

MES-20-246
LUCAS
185 mm

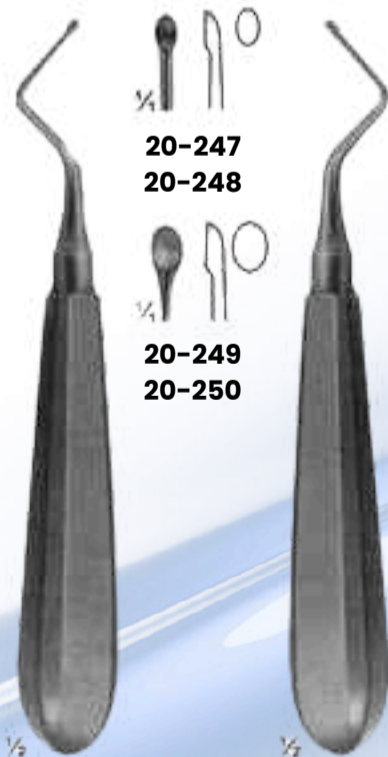

MES-20-247 -248
KERPEL
145 mm

MES-20-249 - 250
KERPEL
145 mm

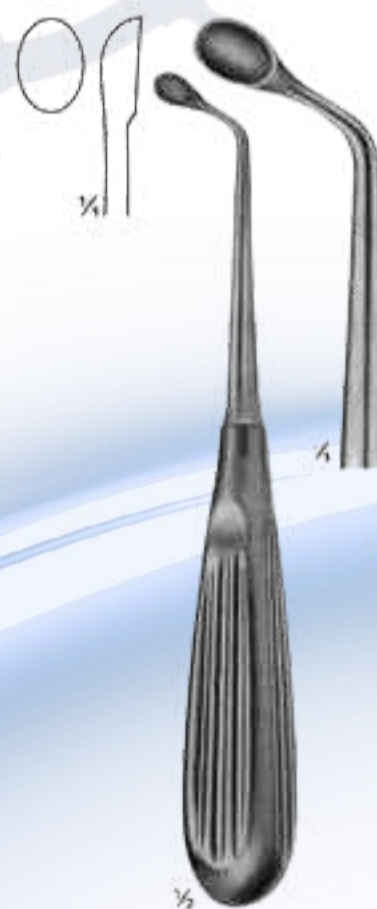

MES- 20-251
UFFENORDE
170 mm

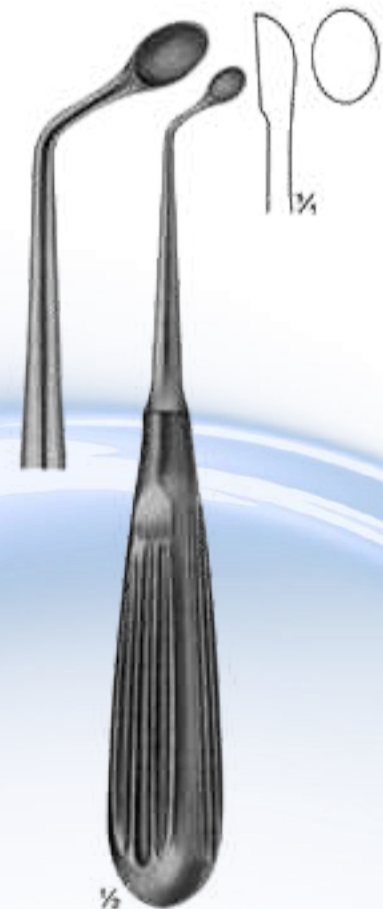

MES-20-252
UFFENORDE
170 mm

Bone Currettes



MES-20-253-259
BRUNS
165 mm

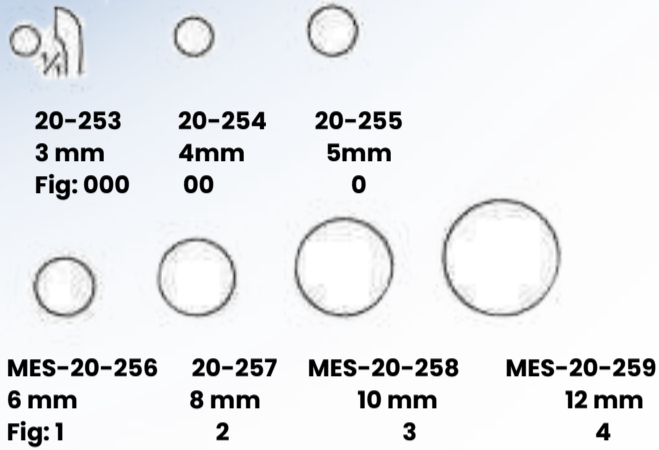

MES-20-260 - 266
SCHEDE
170 mm

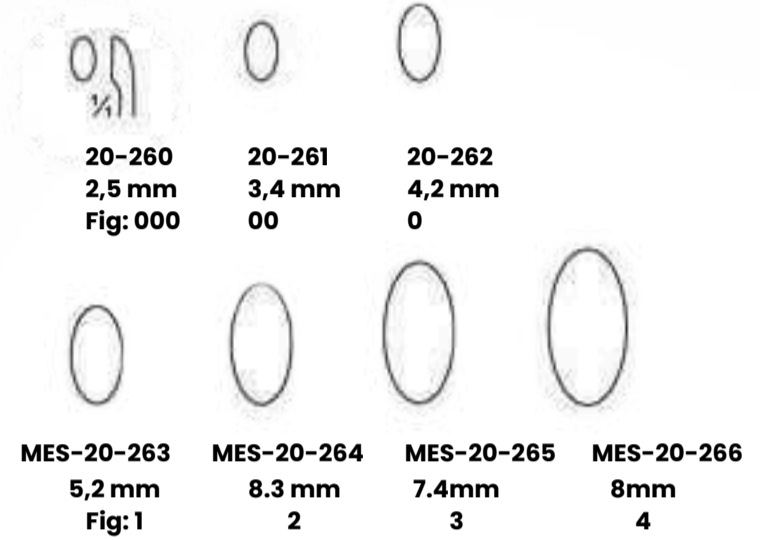

MES-20-267 - 276
VOLKMANN
170 mm

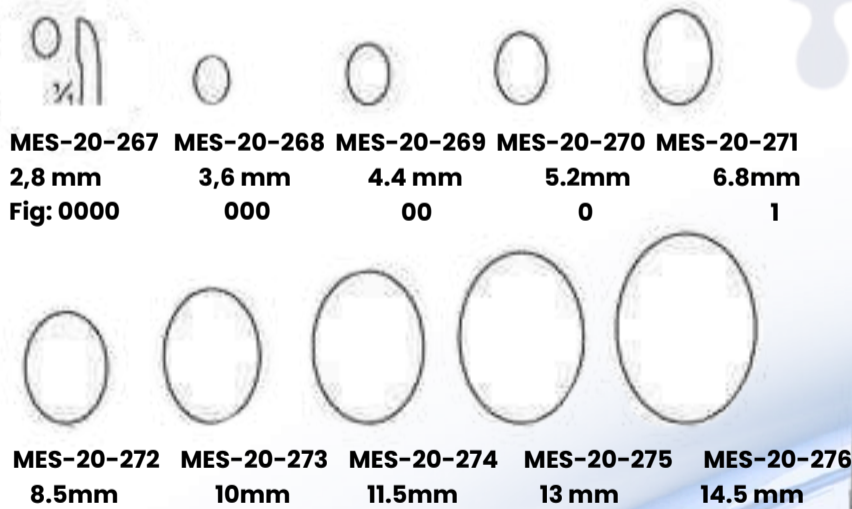

MES-20-277 - 278
WILLIGER
170 mm

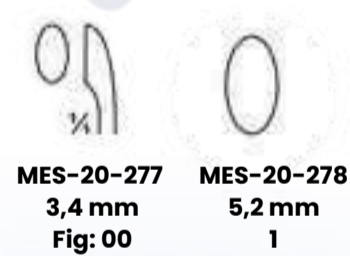

Bone Currettes



MES-20-279
1,8 mm

MES-20-280
2,0 mm

MES-20-281
2,4 mm

MES-20-282
2,6 mm

MES-20-283
2,8 mm

MES-20-279 - 283
LEMPERT
215mm



MES-20-284
4,4 mm
Fig: 00

MES-20-285
5,2 mm
Fig: 0

MES-20-286
6,8 mm
Fig: 1

MES-20-284 - 286
HALLE
215 mm



MES-20-287
4,4 mm
Fig: 0000

MES-20-288
5,2 mm
Fig: 000

MES-20-289
5,2 mm
Fig: 00

MES-20-290
6,8 mm
Fig: 0

MES-20-287 - 290
DAUBENSPECK
200mm



MES-20-291
3,6 mm
Fig: 000

MES-20-292
4,4 mm
Fig: 00

MES-20-293
5,2 mm
Fig: 0

MES-20-294
6,8 mm
Fig: 1

MES-20-291 - 294
250 mm



MES-20-295
3,6 mm
Fig: 000

MES-20-296
4,4 mm
Fig: 00

MES-20-297
5,2 mm
Fig: 0

MES-20-298
6,8 mm
Fig: 1

MES-20-295 - 298
250mm



MES-20-299
3 mm







MES-20-300
4 mm

MES-20-301
5 mm

MES-20-299 - 301
BUSHE
250 mm

[Back to index](#)

Bone Currettes

 <p>MES-20-302 TESSIER 220mm</p>	 <p>MES-20-303 - 305 SIMON 235 mm</p>	 <p>MES-20-306 - 311 SIMON 240mm</p>
 <p>MES-20-312 3,6 mm Fig: 000</p> <p>MES-20-313 4,4 mm Fig: 00</p> <p>MES-20-314 5,2 mm Fig: 0</p> <p>20-312 - 314 CASPAR 220 mm</p>	 <p>MES-20-315 3,6 mm Fig: 000</p> <p>MES-20-316 4,4 mm Fig: 00</p> <p>MES-20-317 5,2 mm Fig: 0</p> <p>20-315 - 317 CASPAR 220 mm</p>	 <p>MES-20-318 4 mm</p> <p>MES-20-319 5mm</p> <p>MES-20-320 6 mm</p> <p>20-318 - 320 CASPAR toothed 220 mm</p>

Bone Currettes

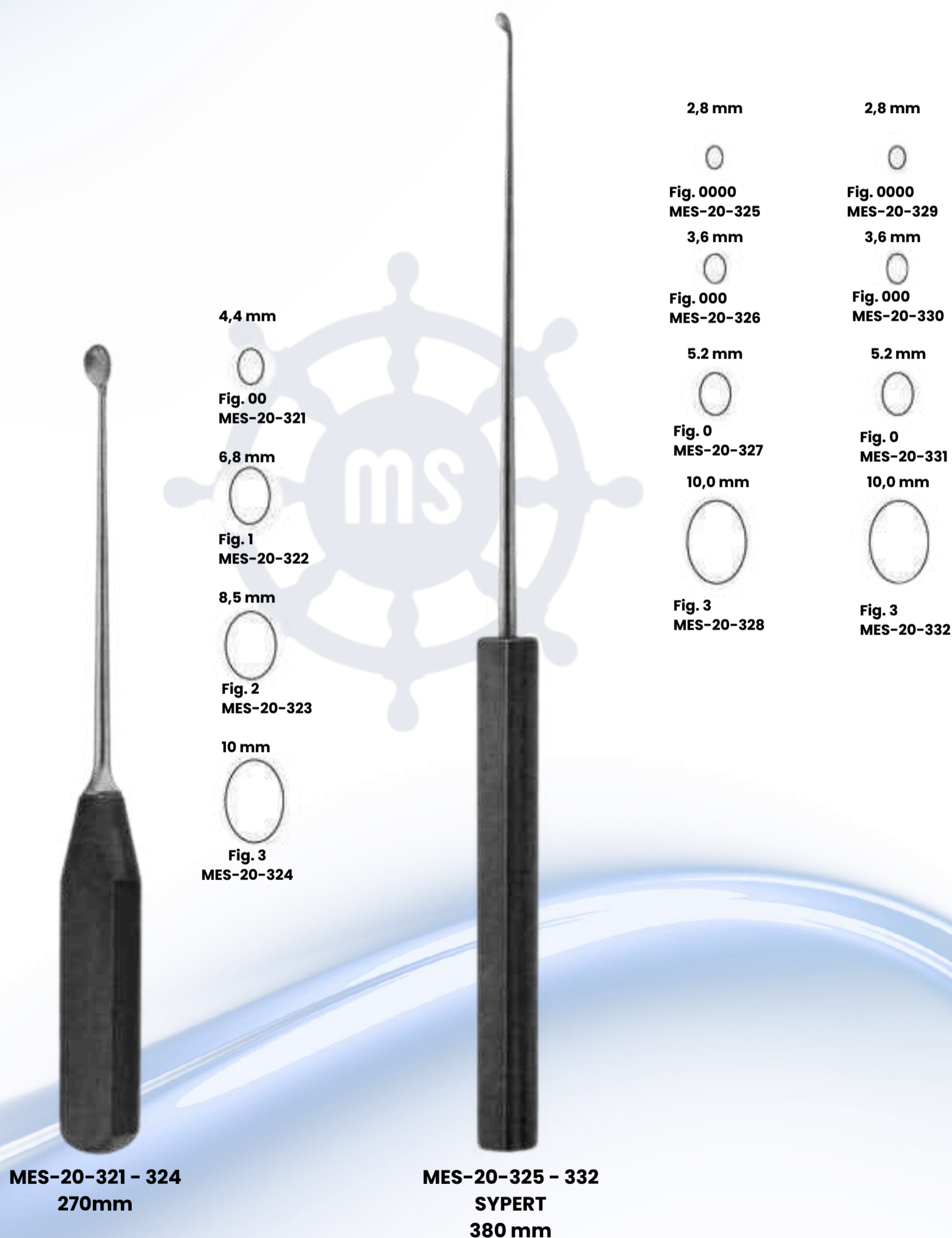

Bone File and Rasps



MES-20-211
JOSEPH
fine, chequered



MES-20-211
7,5 mm



MES-20-212
9mm

MES-20-212
coarse, chequered
165 mm



MES-20-215
MALTZ
down stroke
180 mm



9mm



MES-20-216
AUFRICHT
up stroke

MES-20-217
down stroke
220 mm



MES-20-216
9 mm



MES-20-217
9mm



MES-20-213
LEWIS fine, teeth



MES-20-213
8 mm



MES-20-214
8 mm
coarse, teeth
175 mm



MES-20-218
GALLAHER
190mm



6,5 mm

Bone File and Rasps



MES-20-219 7,5 mm
FOMON
215mm

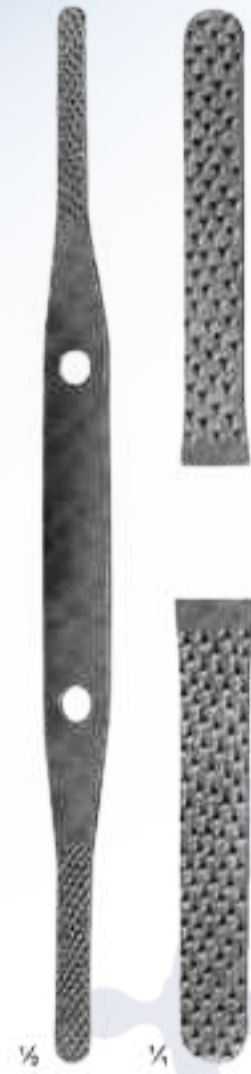

MES-20-220 7,5 mm
FOMON
215mm

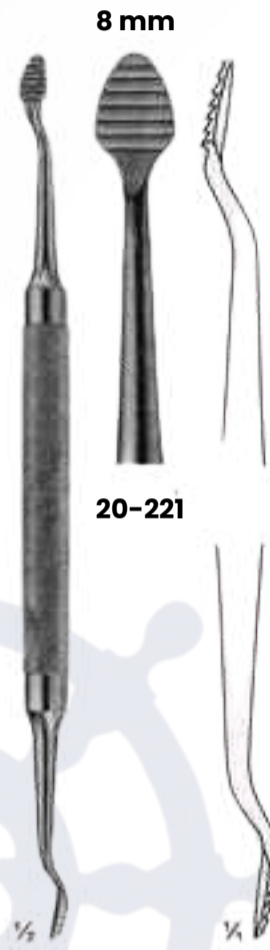

MES-20-221 - 223 5 mm
MILLER
180 mm

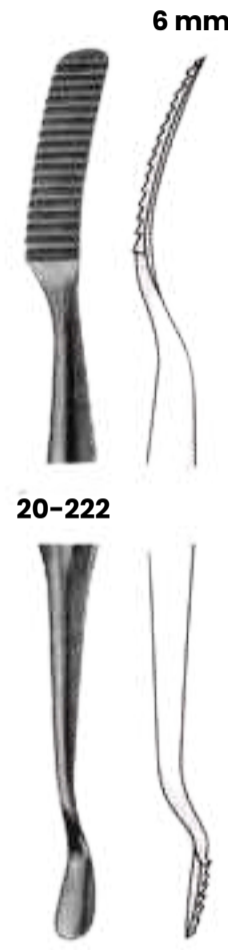

4.3 mm



5 mm



MES-20-224 - 228
205 mm



MES-20-224
12/14



MES-20-225
16/20



MES-20-226
24/30



MES-20-227
36/44



MES-20-228
52/62

[Back to index](#)

Bone File and Rasps

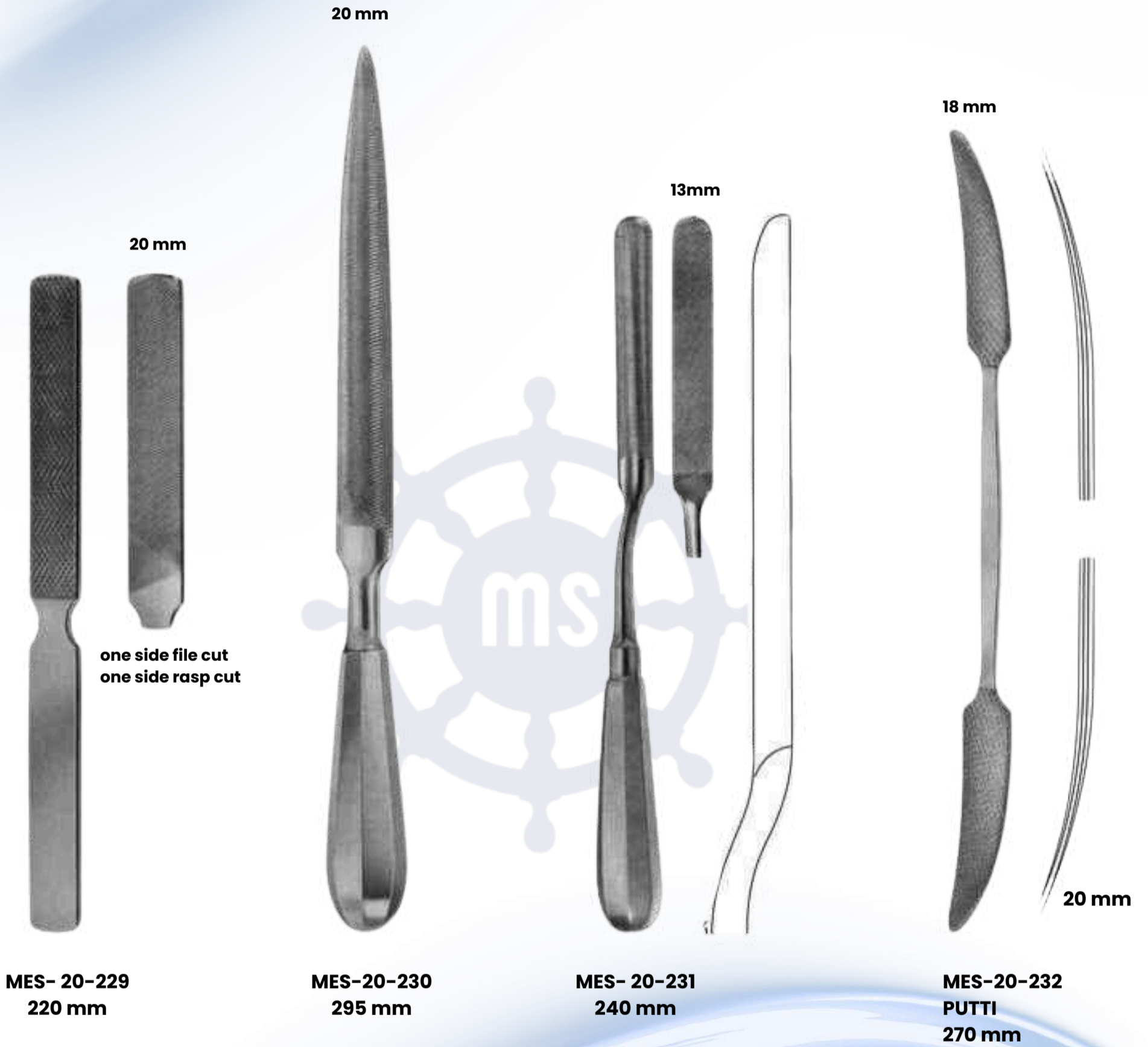

Elevators and Bone Levers

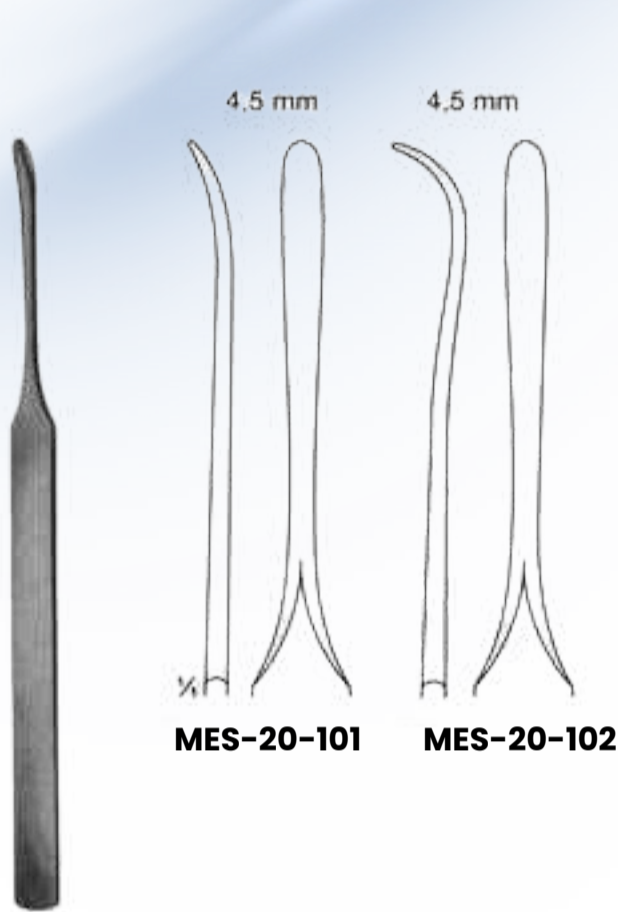

MES-20-101

MES-20-102

MES-20-101 - 102
KONIG
155 mm

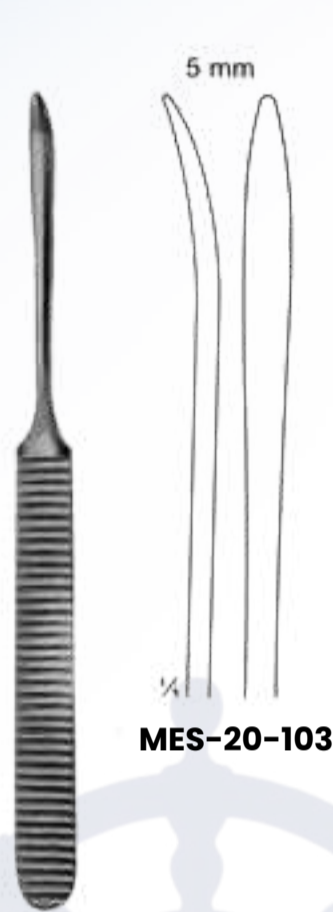

MES-20-103

MES- 20-103
WILLIGER
165 mm

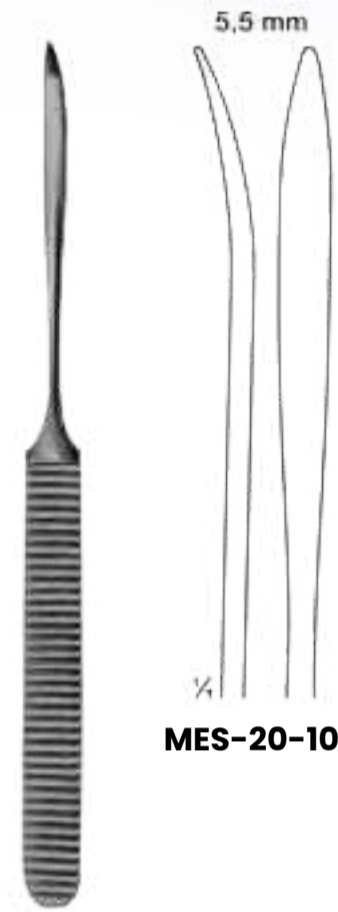

MES-20-104

MES-20-104
WILLIGER
170 mm

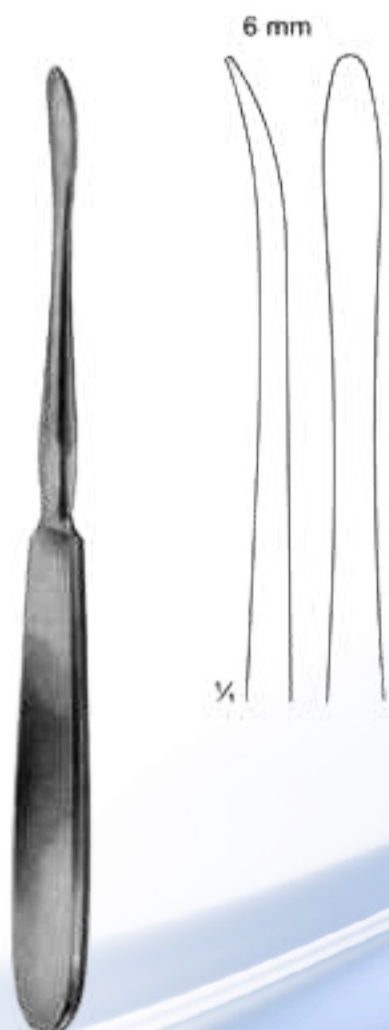

MES-20-105
QUERVAIN
195 mm

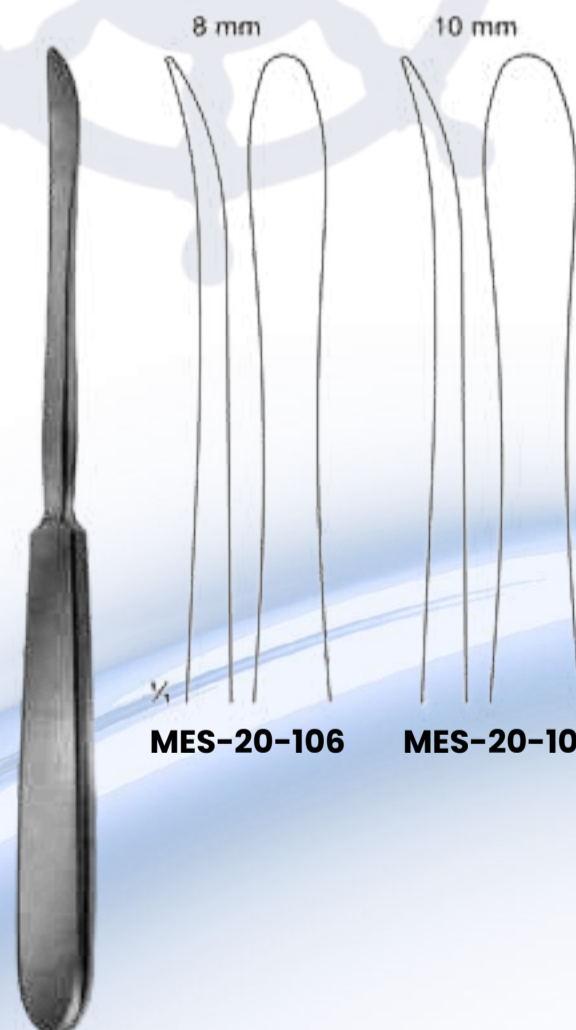

MES-20-106

MES-20-107

MES-120-106 - 107
LANGENBACK
195 mm

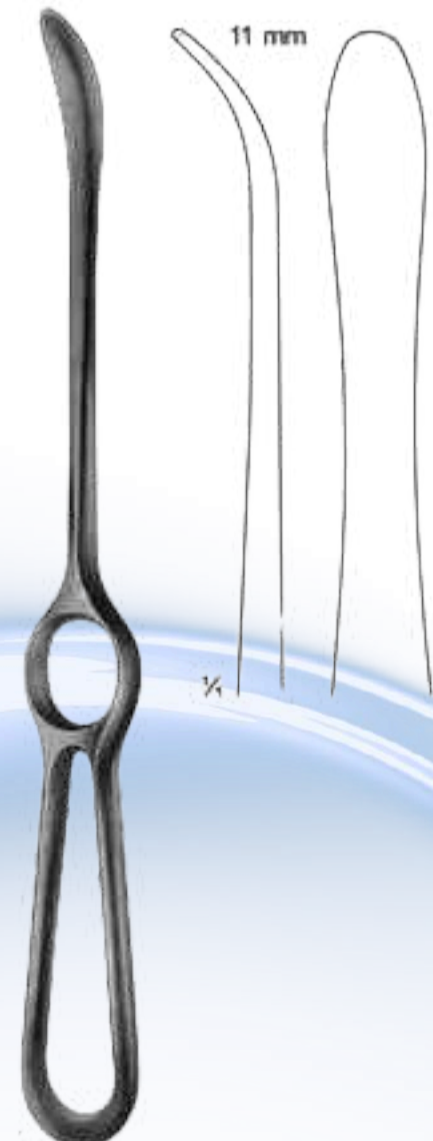

MES- 20-108
LANGENBACK
230mm

Bone Levers

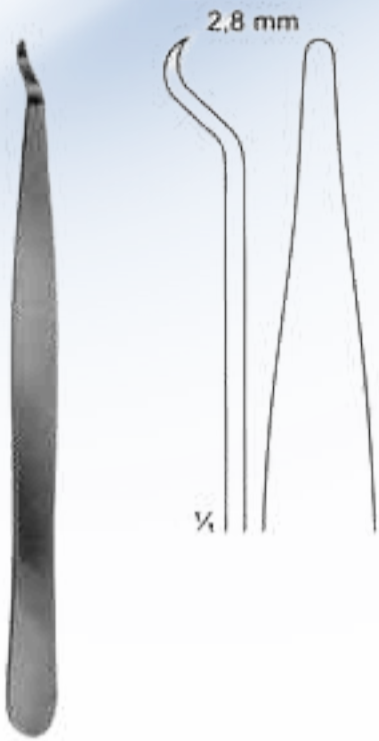

MES-20-109
140mm

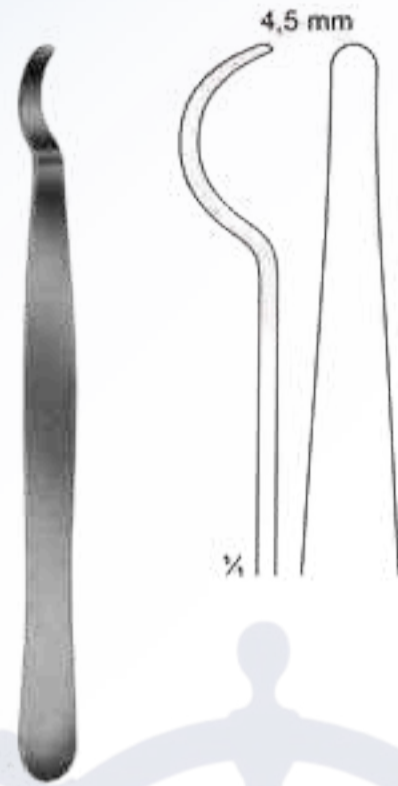

MES-20-110
150mm

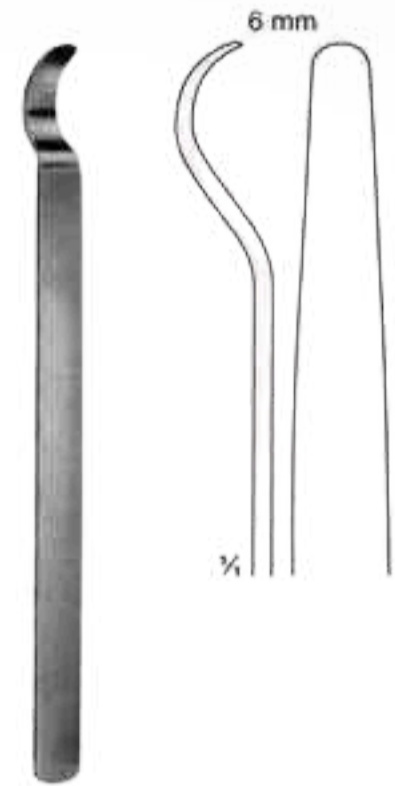

MES-20-111
150mm

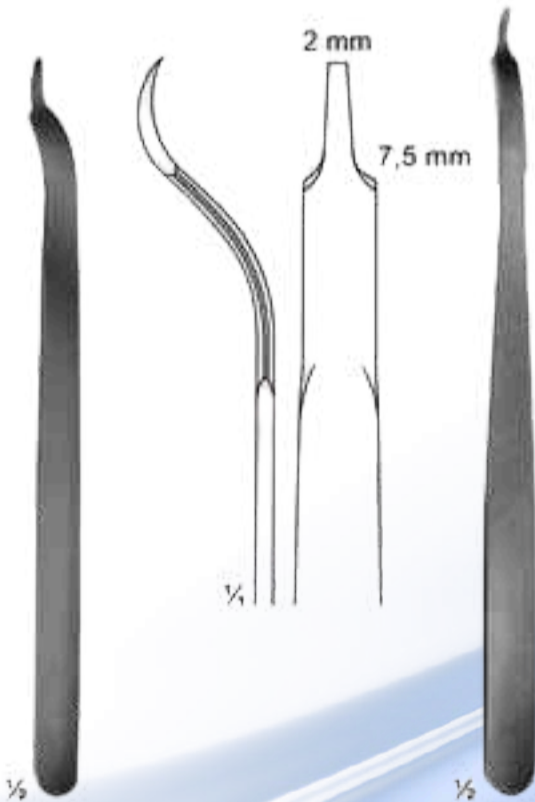

MES-20-112
BUCK-GRAMCKO
150mm



MES-20-113
160mm



MES-20-114
160mm



MES-20-115
125mm

Bone Levers



MES-20-116
LANE TRETOWAN
 215mm

MES-20-117
LANE
 255mm

MES-20-118
LANGE-HOMANN
 250mm

MES-20-119 - 120
LANGE-HOMANN
MES-20-119 265mm
MES-20-120 280mm

Bone Levers

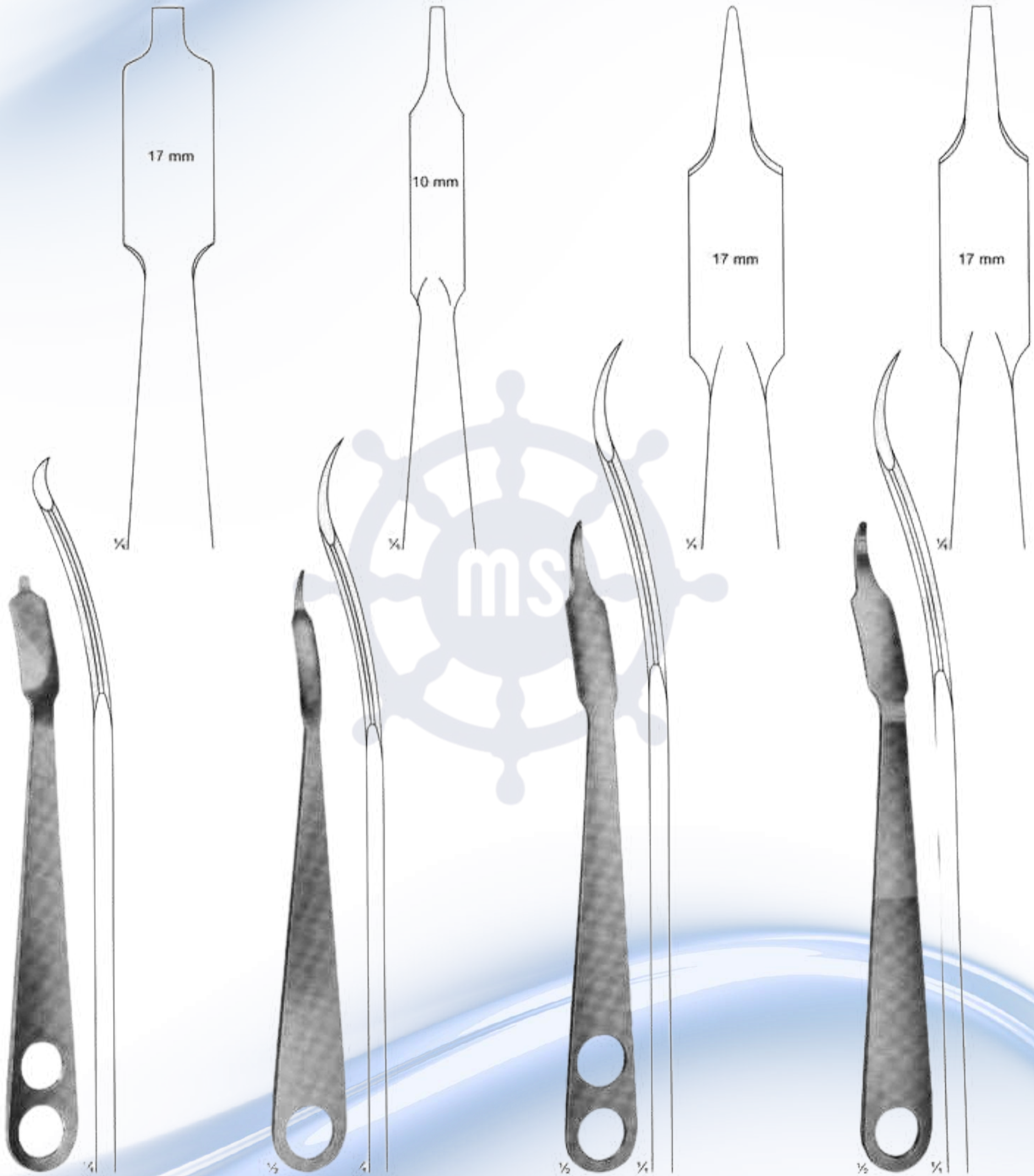

MES-20-121
WAGNER
220 mm

MES-20-122
220 mm

MES- 20-123
240 mm

MES-20-124
240 mm

Bone Levers

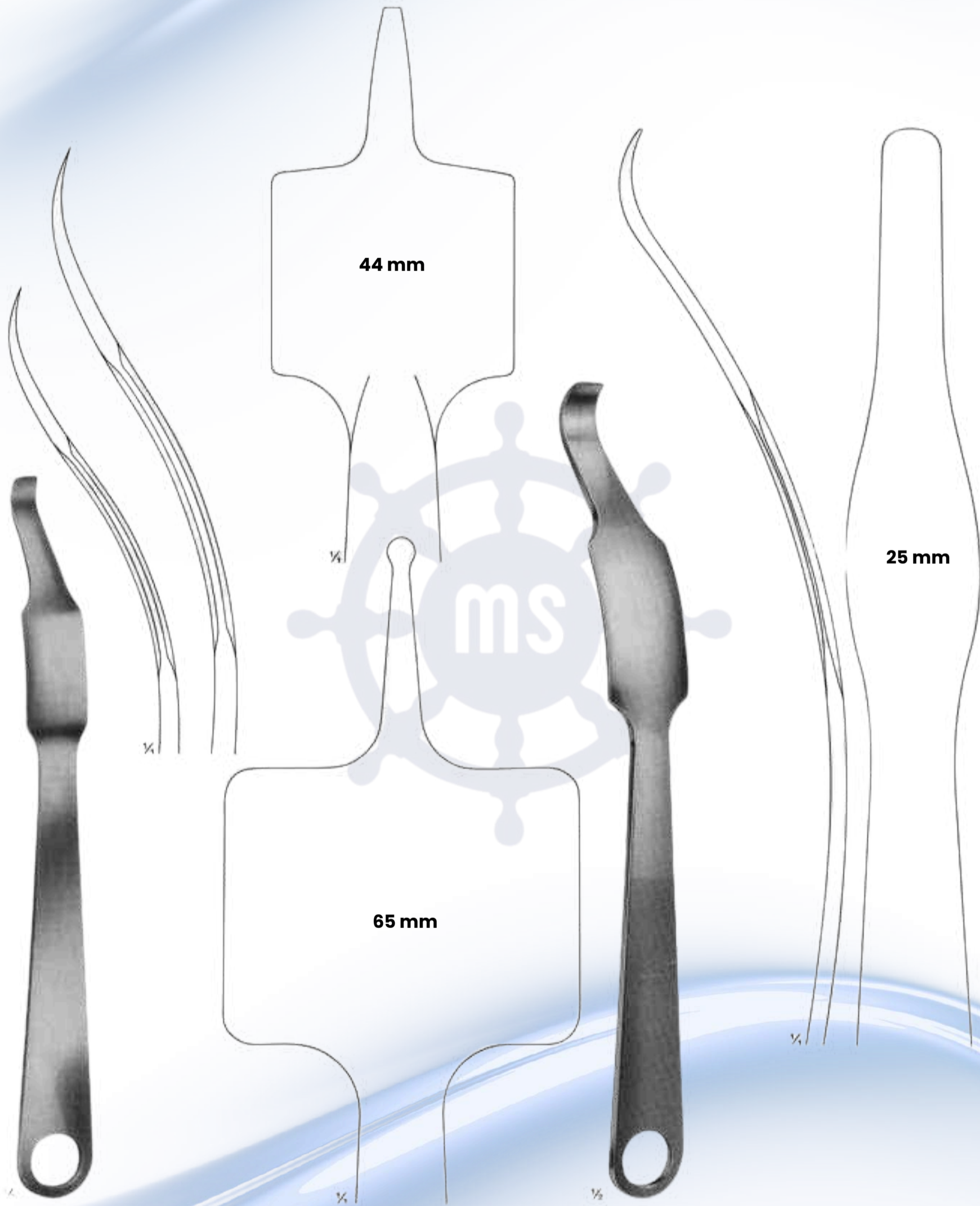

MES-20-125 - 126
VERBRUGGE-MULLER
MES-20-125 240 mm
MES-20-126 255 mm

MES-20-127
260 mm

Bone Levers

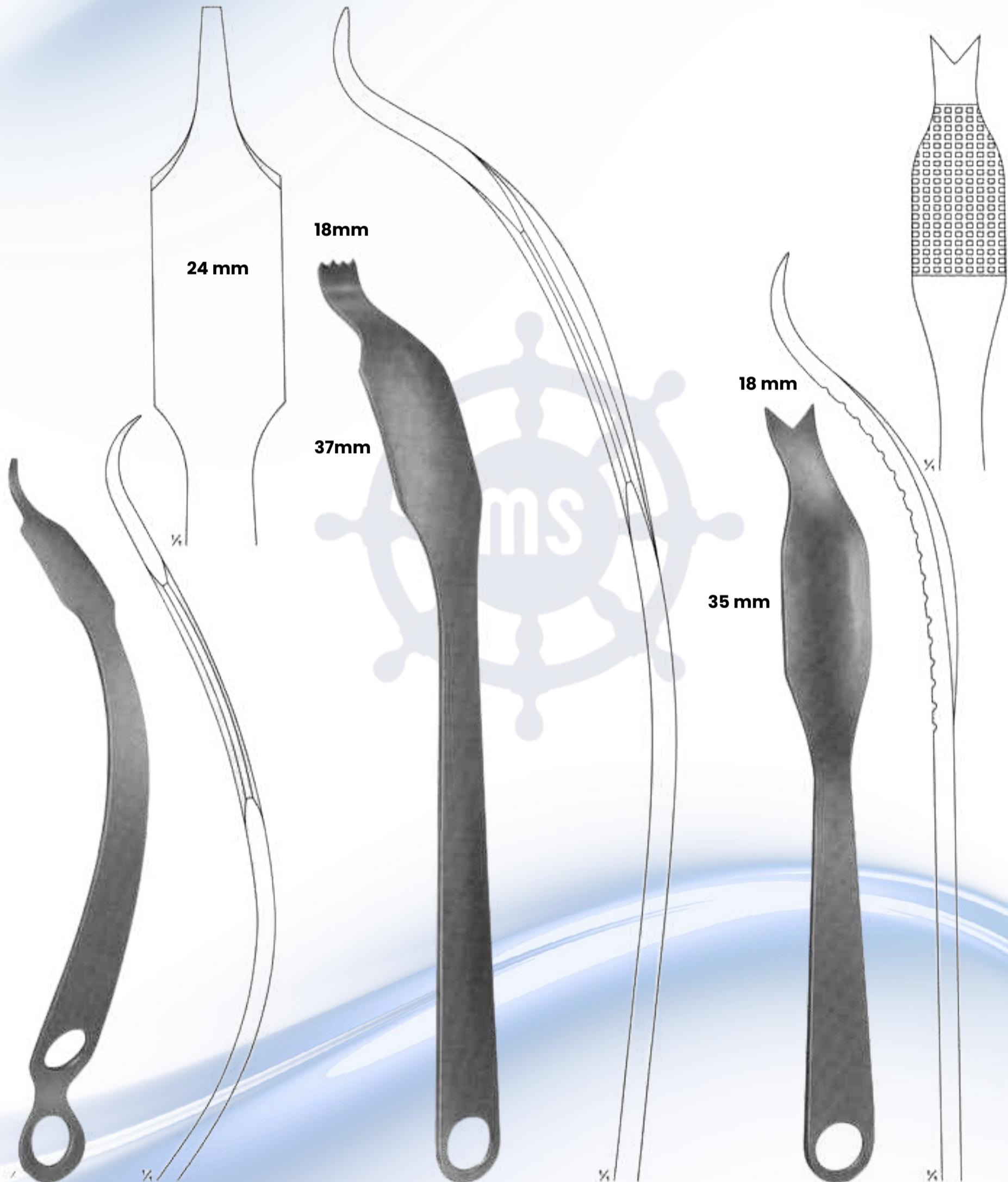

MES-20-128
HOHMANN-ALDINGER
 270mm

MES-20-129
SCHUMACHER mod. WAGNER
 345 mm

MES-20-130
SCHUMACHER
 290 mm

[Back to index](#)

Special Bone Levers

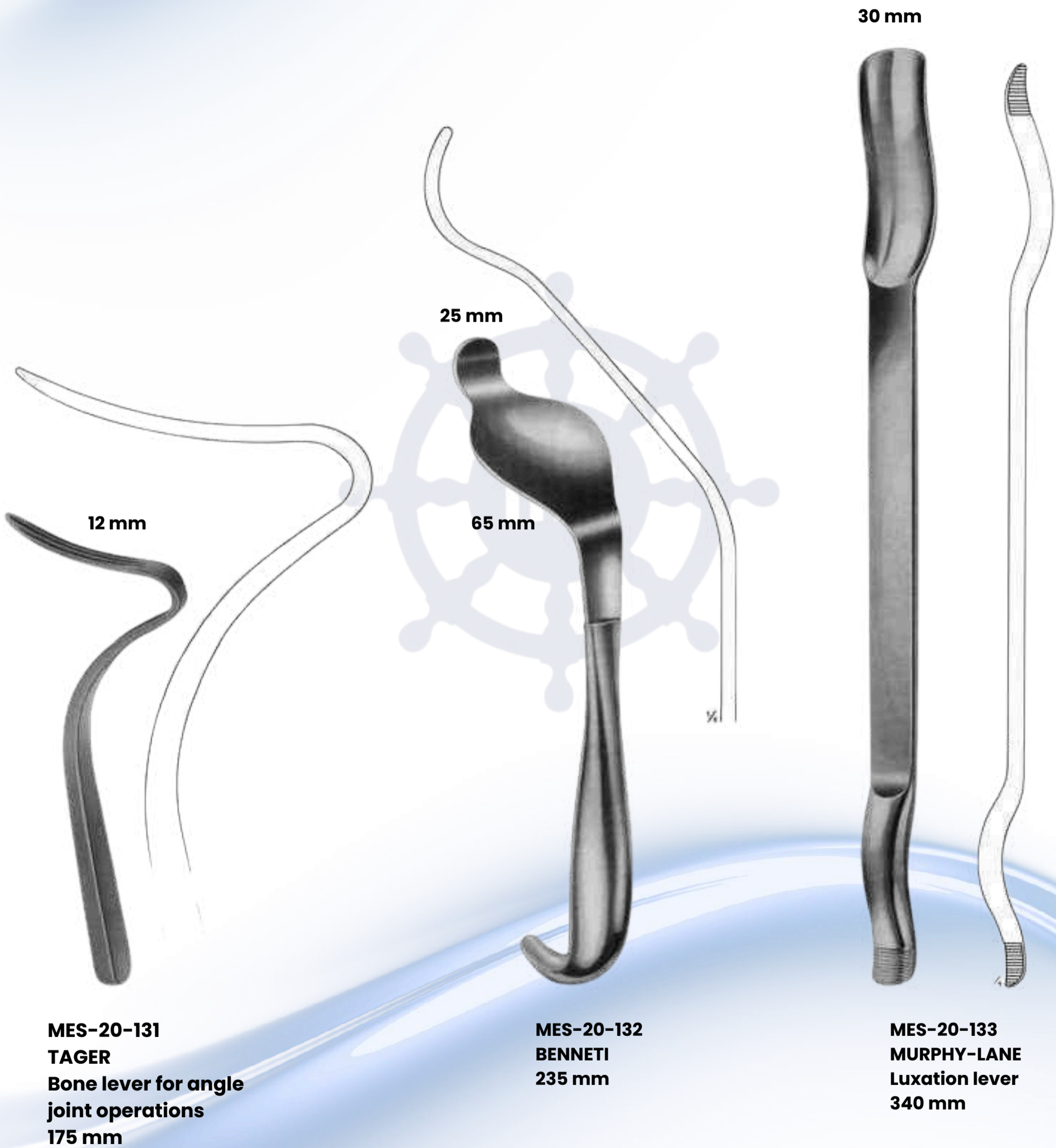

Tampers - Osteotomes, Chisels and Gouges

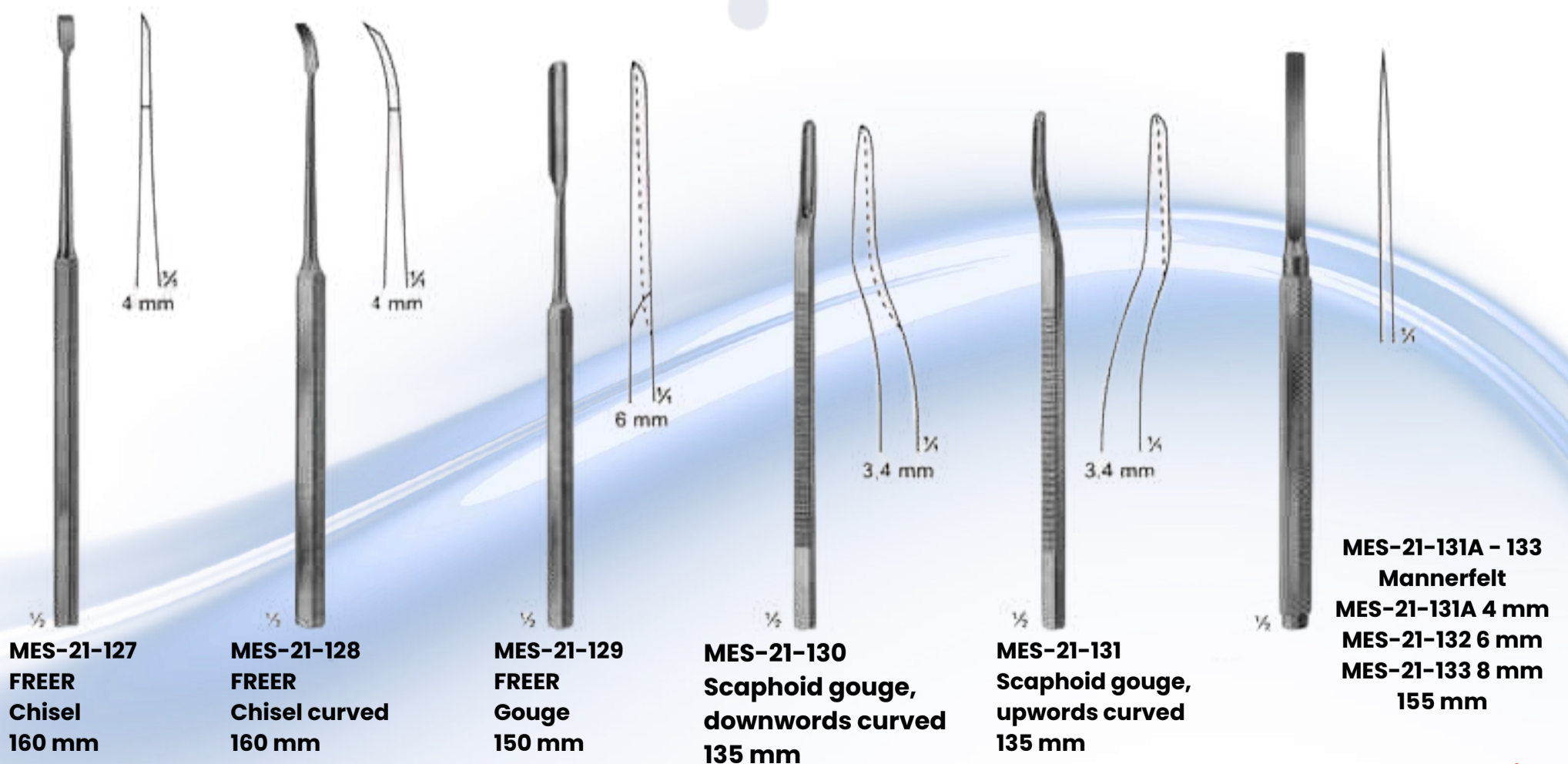
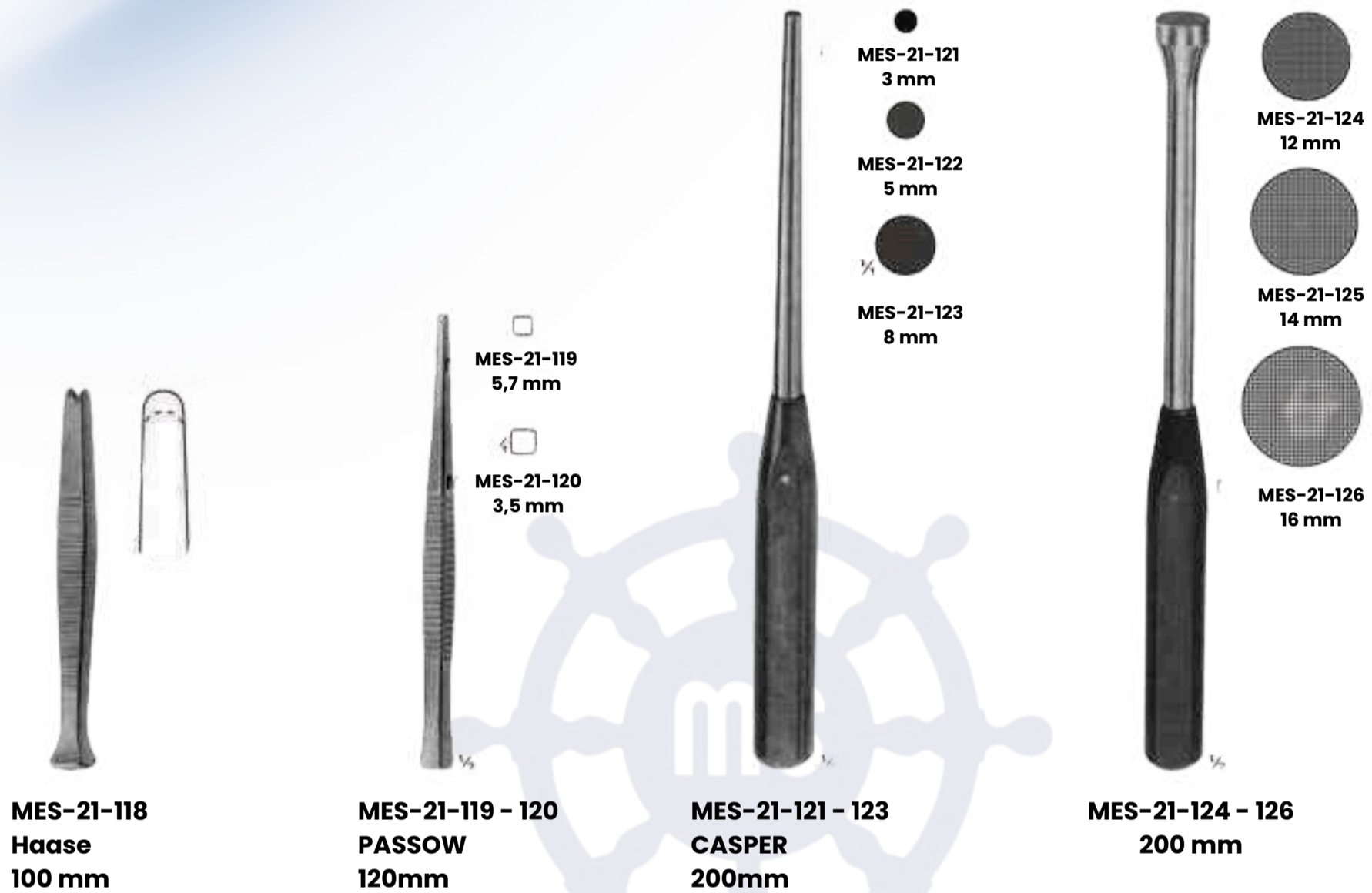

[Back to index](#)

Osteotomes Chisels and Gouges

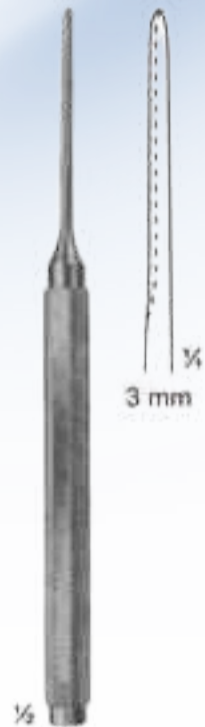

MES-21-134
Mannerfelt
155 mm

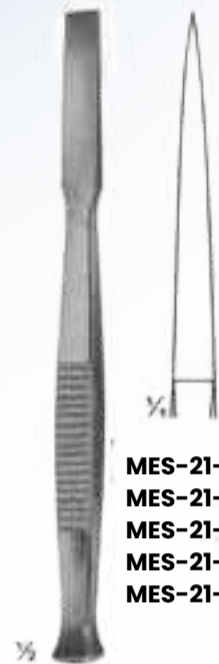

MES-21-135 - 139
Osteotome
140 mm

MES-21-135 4 mm
MES-21-136 6 mm
MES-21-137 8 mm
MES-21-138 10mm
MES-21-139 12 mm



MES-21-140 - 144
Chisels
140 mm

MES-21-140 4 mm
MES-21-141 6 mm
MES-21-142 8 mm
MES-21-143 10 mm
MES-21-144 12mm

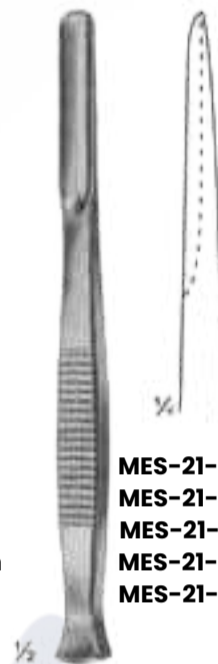

MES-21-145 - 149
Gouges.
140 mm

MES-21-145 4 mm
MES-21-146 6 mm
MES-21-147 8 mm
MES-21-148 10 mm
MES-21-149 12 mm

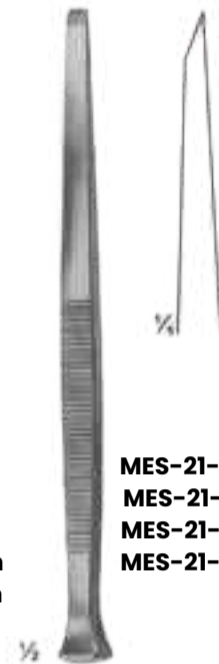

PARTSCH
MES-21-150 - 153
Chisels
140 mm

MES-21-150 3 mm
MES-21-151 4 mm
MES-21-152 5 mm
MES-21-153 6 mm



PARTSCH
MES-21-154 - 158
Chisels
170 mm

MES-21-154 3 mm
MES-21-155 4 mm
MES-21-156 5 mm
MES-21-157 6 mm
MES-21-158 7mm

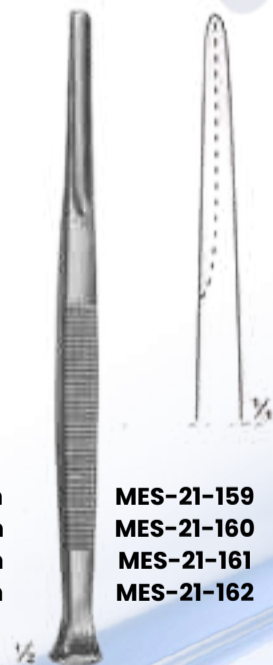

PARTSCH
MES-21-159 - 162
Gouges
140 mm

MES-21-159 3 mm
MES-21-160 4 mm
MES-21-161 5 mm
MES-21-162 6 mm



PARTSCH
MES-21-163 - 167
Gouges
170 mm

MES-21-163 3 mm
MES-21-164 4 mm
MES-21-165 5 mm
MES-21-166 6 mm
MES-21-167 7 mm



LUCAS
MES-21-168 - 169
Chisels
160mm

MES-21-168 4 mm
MES-21-169 6 mm

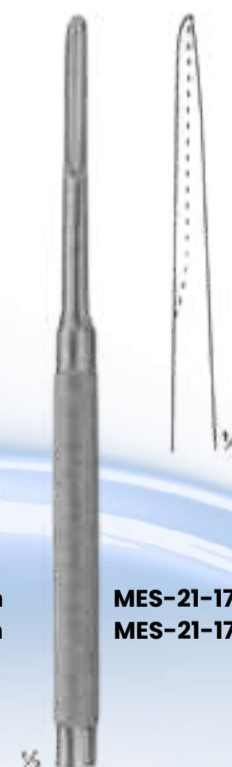

LUCAS
MES-21-170 - 171
Gouges
160 mm

MES-21-170 3 mm
MES-21-171 5mm

Osteotomes Chisels and Gouges

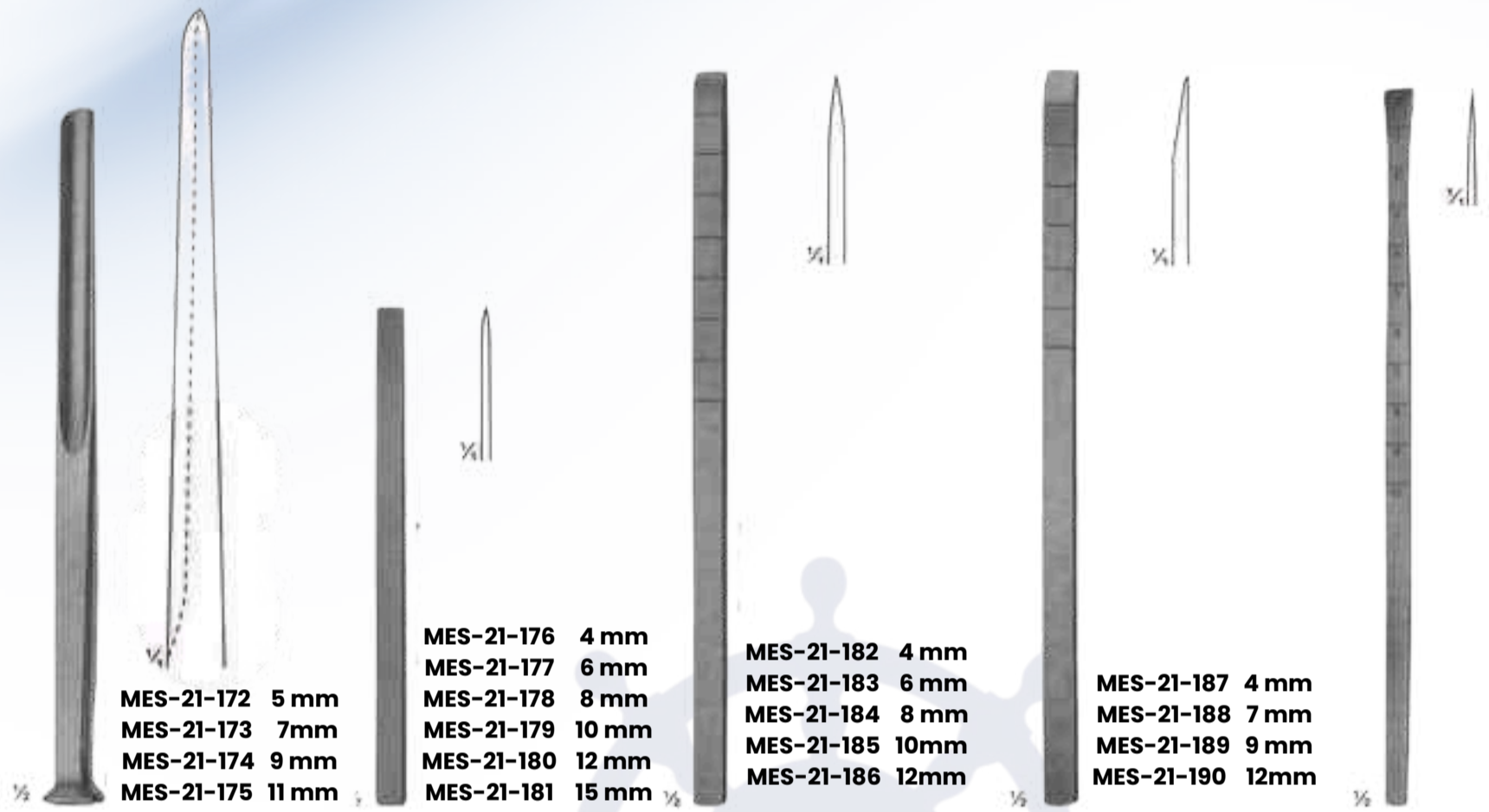

- | | | | |
|------------------|------------------|-----------------|-----------------|
| MES-21-172 5 mm | MES-21-176 4 mm | MES-21-182 4 mm | MES-21-187 4 mm |
| MES-21-173 7mm | MES-21-177 6 mm | MES-21-183 6 mm | MES-21-188 7 mm |
| MES-21-174 9 mm | MES-21-178 8 mm | MES-21-184 8 mm | MES-21-189 9 mm |
| MES-21-175 11 mm | MES-21-179 10 mm | MES-21-185 10mm | MES-21-190 12mm |
| | MES-21-180 12 mm | MES-21-186 12mm | |
| | MES-21-181 15 mm | | |

ALEXANDER
MES-21-172 - 175
Gouges
170 mm

LAMBOTTE
MES-21-176 - 181
Osteotome
125 mm

COTTLE
MES-21-182 - 186
Osteotome with depth markings
180 mm

COTTLE
MES-21-187 - 190
Chisel-Osteotomes with depth markings
180 mm

COTTLE
MES-21-191
Fishtail Chisel with protected ends
180mm

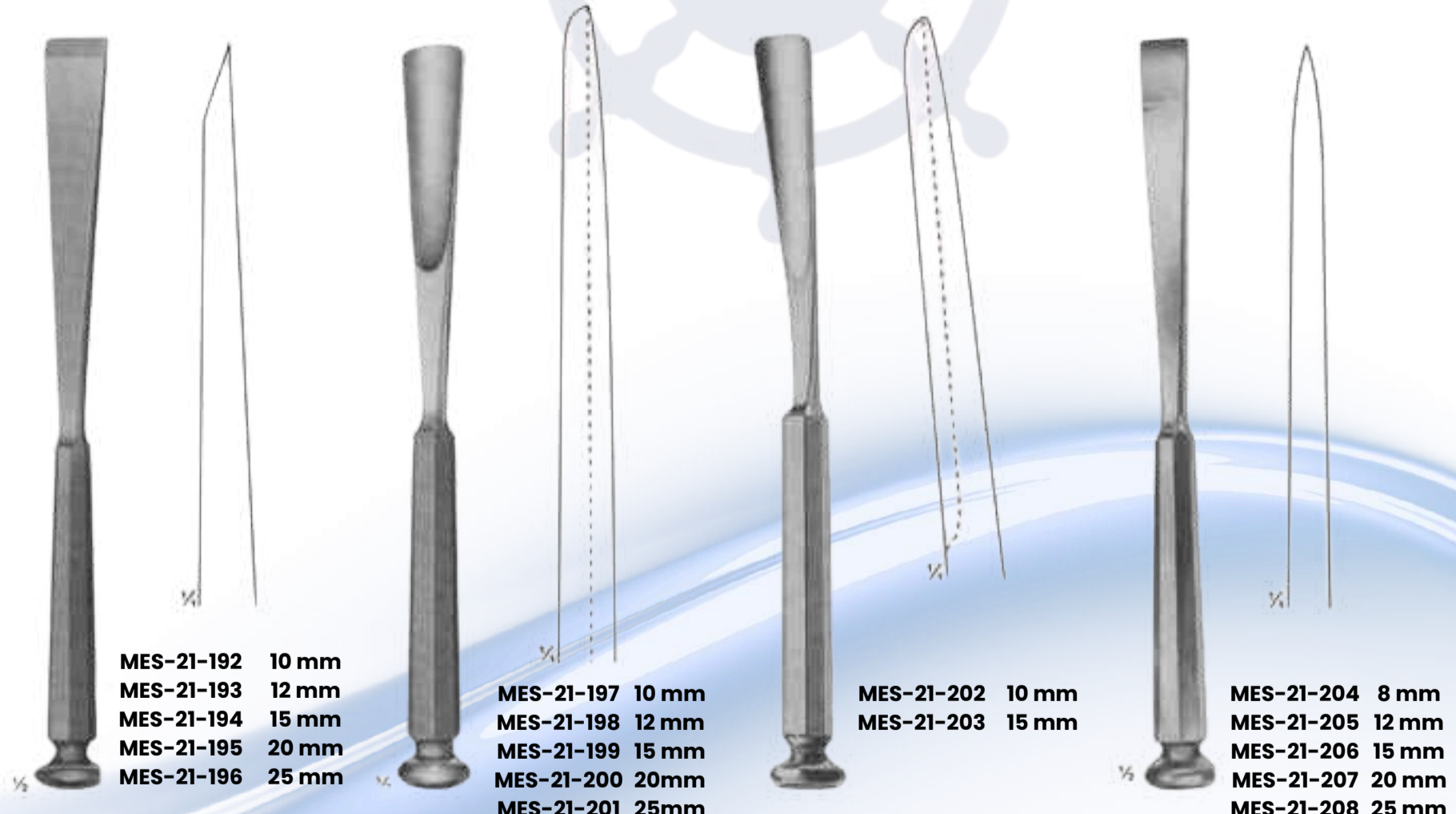

- | |
|------------------|
| MES-21-192 10 mm |
| MES-21-193 12 mm |
| MES-21-194 15 mm |
| MES-21-195 20 mm |
| MES-21-196 25 mm |

- | |
|------------------|
| MES-21-197 10 mm |
| MES-21-198 12 mm |
| MES-21-199 15 mm |
| MES-21-200 20mm |
| MES-21-201 25mm |

- | |
|------------------|
| MES-21-202 10 mm |
| MES-21-203 15 mm |

- | |
|------------------|
| MES-21-204 8 mm |
| MES-21-205 12 mm |
| MES-21-206 15 mm |
| MES-21-207 20 mm |
| MES-21-208 25 mm |

STILLE
MES-21-192 - 196
Chisels
205 mm

STILLE
MES-21-197 - 201
Gouges
205 mm

WALTER
MES-21-202 - 203
Osteotomes
gouges for taking
grafts from the rib
205 mm

STILLE
MES-21-204 - 208
Osteotomes
205 mm

[Back to index](#)

Osteotomes



STILLE
 MES-21-209 - 213
 Osteotomes
 205 mm



STILLE
 MES-21-214-218
 Osteotomes, curved
 205 mm



LAMBOTTE
 MES-21-219 - 230
 Osteotomes
 245mm

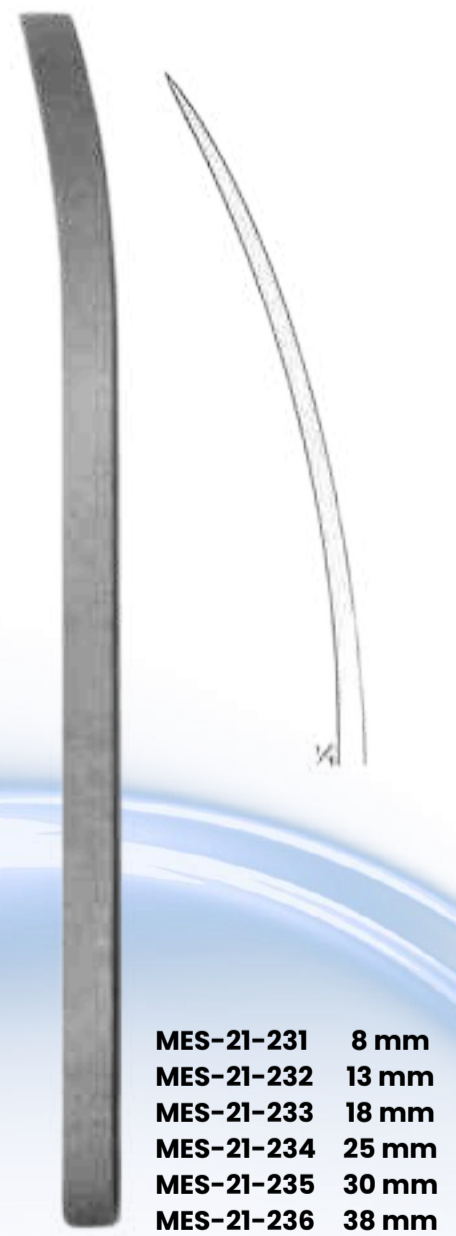

LAMBOTTE
 MES-21-231 - 236
 Osteotomes, curved
 245 mm

Osteotomes, Chisels and Gouges with HARTPRESS -handle

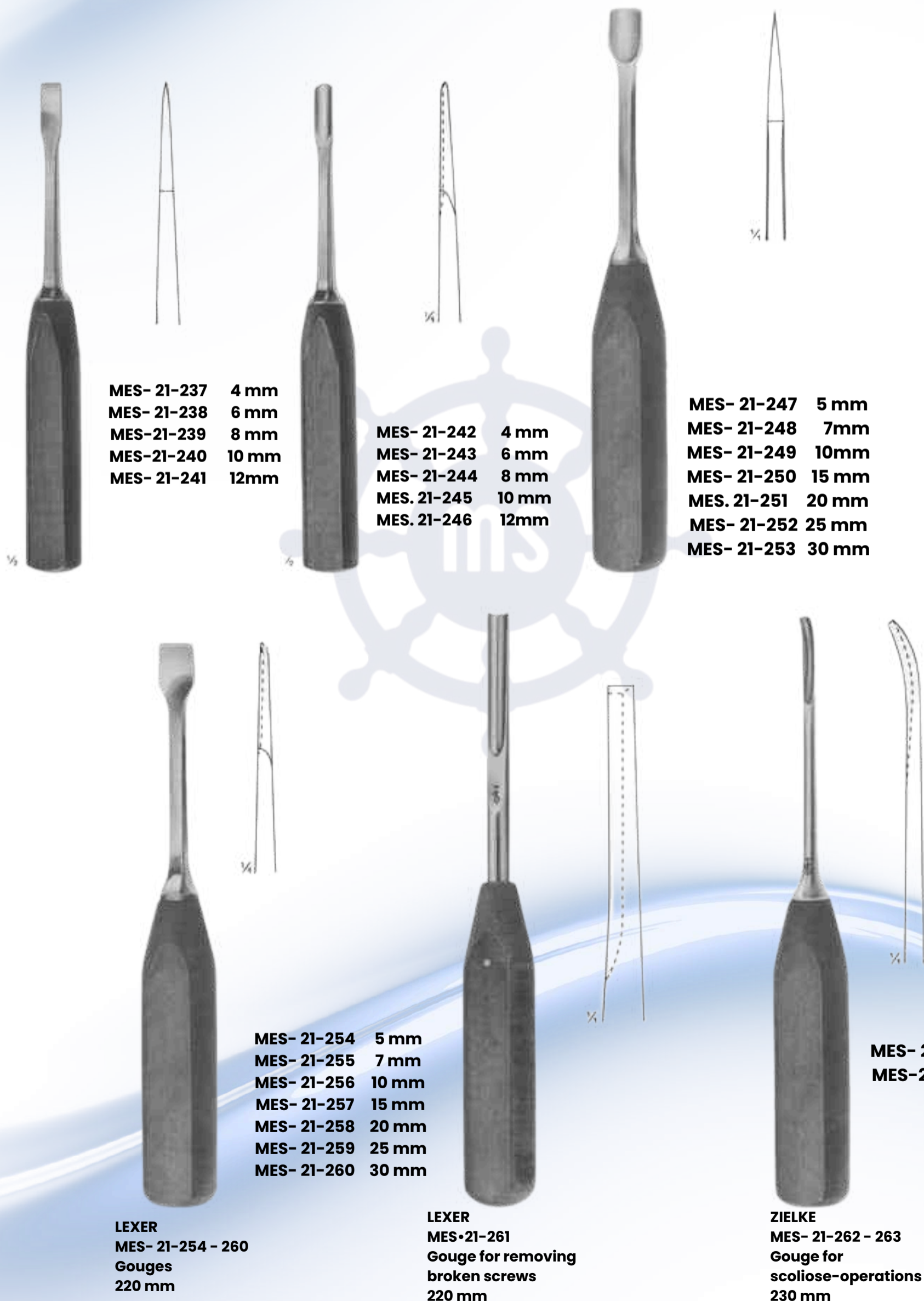

<p>MES- 21-237 4 mm MES- 21-238 6 mm MES-21-239 8 mm MES-21-240 10 mm MES- 21-241 12mm</p>	<p>MES- 21-242 4 mm MES- 21-243 6 mm MES- 21-244 8 mm MES. 21-245 10 mm MES. 21-246 12mm</p>	<p>MES- 21-247 5 mm MES- 21-248 7mm MES- 21-249 10mm MES- 21-250 15 mm MES. 21-251 20 mm MES- 21-252 25 mm MES- 21-253 30 mm</p>
<p>MES- 21-254 5 mm MES- 21-255 7 mm MES- 21-256 10 mm MES- 21-257 15 mm MES- 21-258 20 mm MES- 21-259 25 mm MES- 21-260 30 mm</p>	<p>MES- 21-262 5,5 mm MES-21-283 9.0 mm</p>	

LEXER
MES- 21-254 - 260
Gouges
220 mm

LEXER
MES-21-261
Gouge for removing
broken screws
220 mm

ZIELKE
MES- 21-262 - 263
Gouge for
scoliose-operations
230 mm

[Back to index](#)

Osteotomes, Chisels and Gouges with HARTPRESS -handle



MES-21-264 10 mm
MES-21-265 15 mm

LEXER
MES- 21-264 - 265
Osteotomes.
angled
275 mm



MES- 21-266 10 mm
MES- 21-267 15 mm

LEXER
MES-21-266 - 267
Gouges, angled
275mm



MES- 21-268
Chisel
245 mm



MES- 21-269
Chisel, curved
265 mm

Amputation and Resection Knives



MES-19-110
 Length of blades
 Phalangeal knife
 105 mm



MES-19-111
 Length of blades
 Interosseous knife
 110 mm



MES-19-112
 Length of blades
 Periosteum knife
 with raspatory
 65mm



MES-19-113 - 114
LANGENBECK
 Length of blades
 Resection knives
 55 mm



MES-19-113



MES-19-114

Amputation Retractors

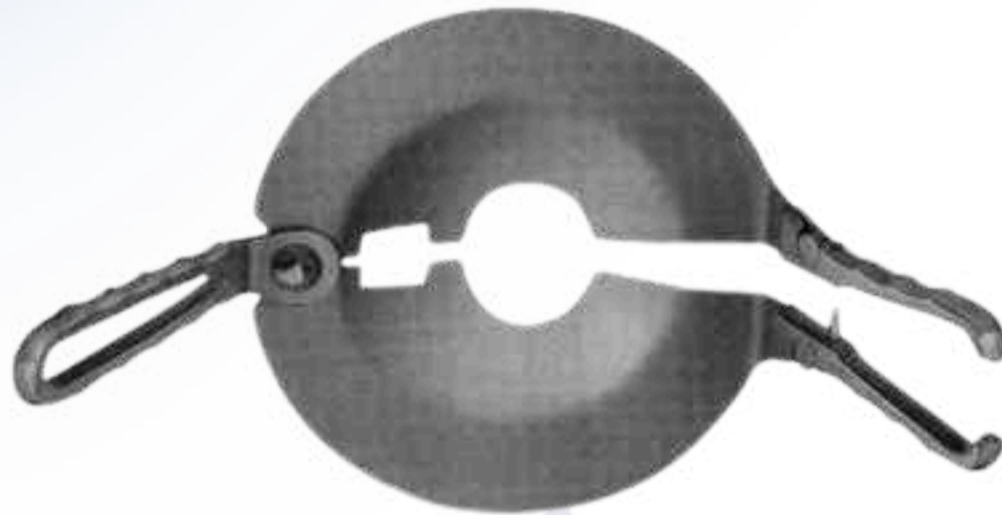

MES-19-115
PERCY
removeable handles

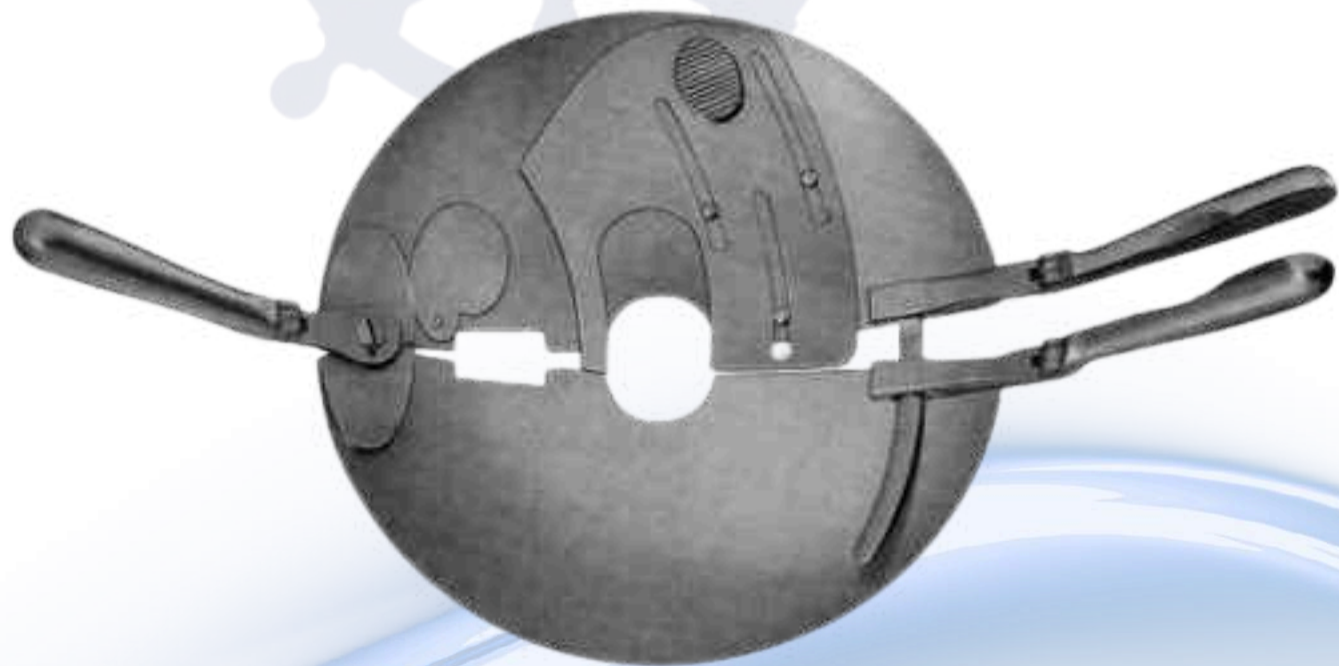

MES-19-116
PERCY
reversible handles

Amputation Saws

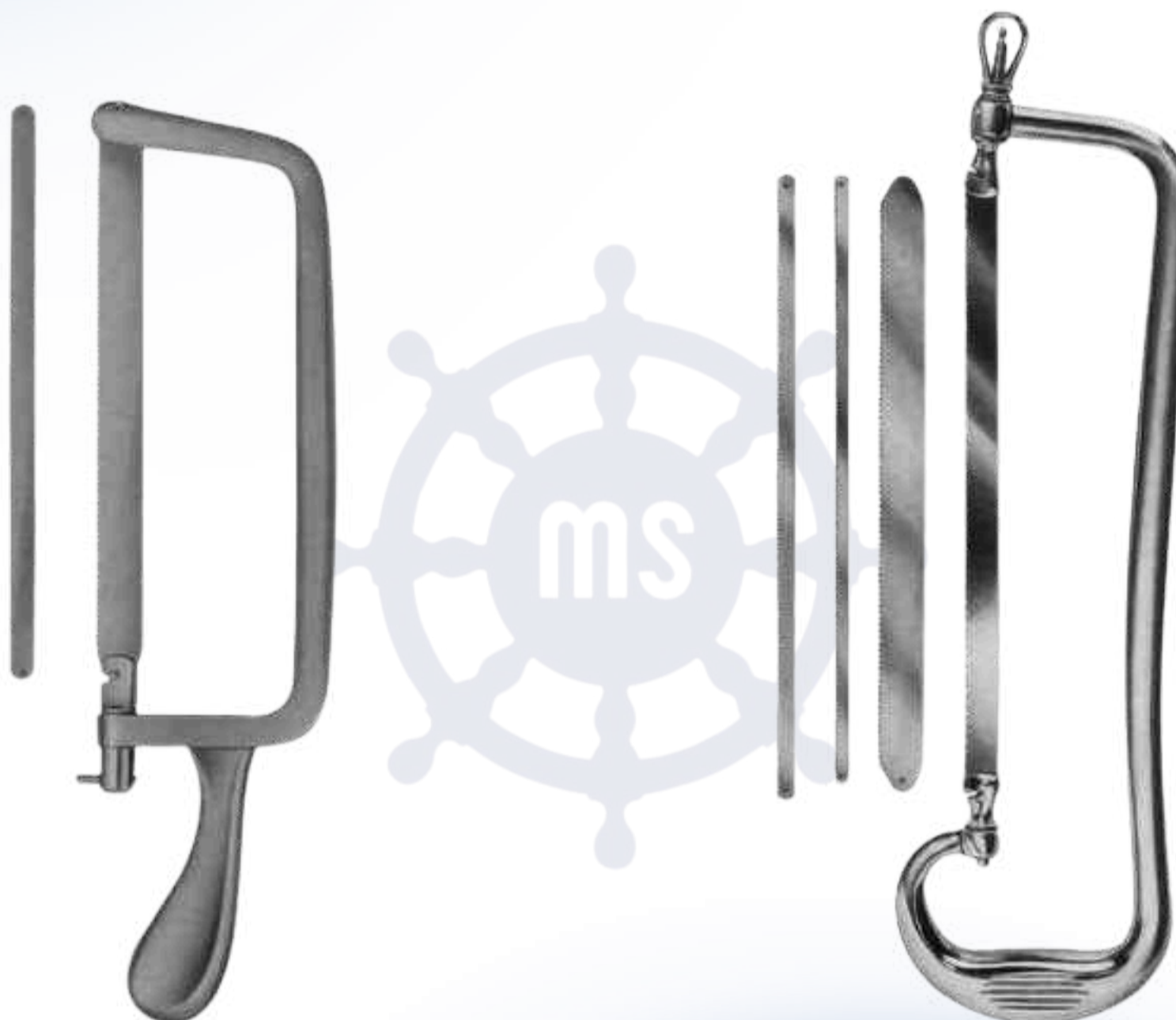

MES-19-117
CHARRIEER
 Length of blade
 215 mm
 complete with one
 saw blade each
 350 mm
 Spare saw blades,
 carbon steel

MES-19-118 12 mm
MES-19-119 20mm

MES-19-120 %
RUST
 Length of blade
 235 mm
 complete with one saw
 blade each
 390 mm
MES-19-121
 Bow only
 Spare saw blades, carbon steel
MES-19-122 6 mm
MES-19-123 8 mm
MES-19-124 12 mm
MES-19-125 20 mm

Amputation Saws



MES-19-126
BIER
 Length of blade
 270mm
 complete with one saw
 blade each
 420mm
 Spare saw blades,
 carbon steel
MES-19-127 4 mm
MES-19-128 6mm
MES-19-129 8 mm



MES-19-130
CHARRIERE
 Length of blade
 180 mm
 Spare saw blades,
 carbon steel
 270 mm
MES-19-131
CHARRIERE
 Length of blade
 240 mm
 Spare saw blades,
 carbon steel
 340 mm



MES-19-132
SATTERLEE
 Length of blade
 200 mm
 Spare saw blades.
 carbon steel
 290 mm



MES-19-133
LANGENBACK
 Length of blade
 115 mm
 Metacarpal saw
 235 mm