



شركة الخدمات البحرية المحدودة  
MARINE SERVICES CO., LTD.



# Cannulae & Dilators Instruments

Precision • Quality • Reliability

## **Cannulae & Dilators**

1. Irrigating Cannulae, Embolus Grasping Forceps, Dilators
2. Biopotome and Aortic Dilators
3. Combined Suction and Irrigation Cannulae

ISO 13485 AND CE

Manufactured & supplied in compliance with international medical standards.

## Irrigating Cannulae, Embolus Grasping Forceps, Dilators

Φ3 mm 4 mm 5 mm 6 mm

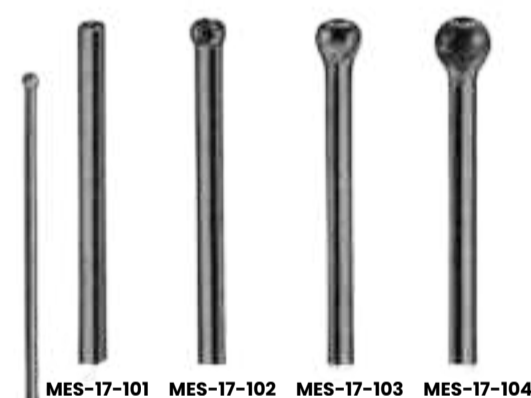

MES-17-101 MES-17-102 MES-17-103 MES-17-104

**MES-17-101 - 104**  
**SCHMID**  
 Vessel irrigating  
 cannulae, malleable,  
 silver plated  
 150mm

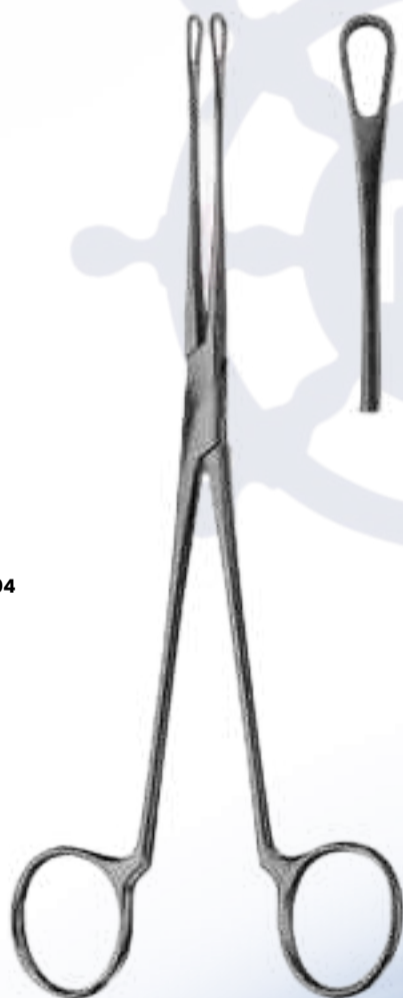

**MES-17-105**  
**BLAKE**  
 Embolus grasping  
 forceps.  
 205 mm

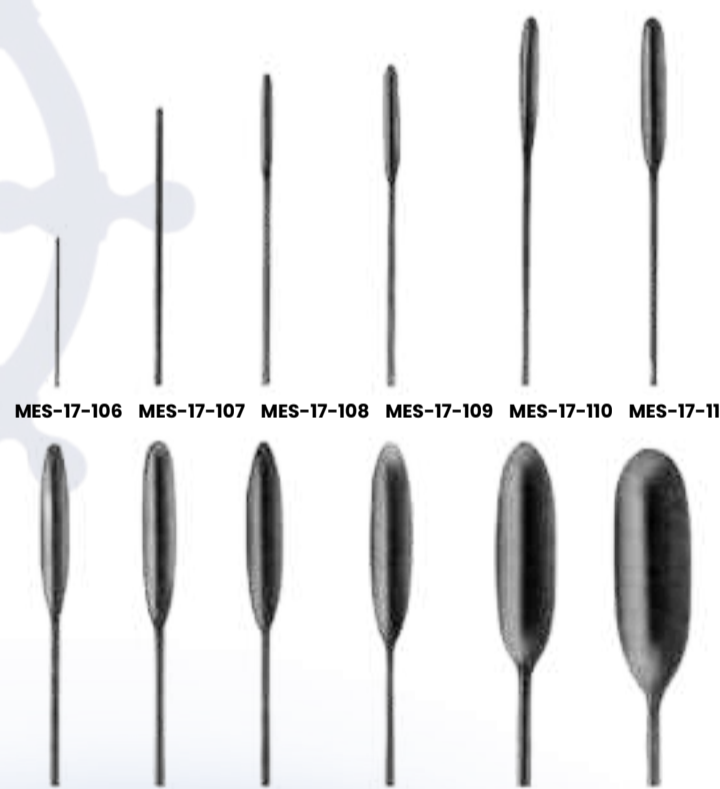

MES-17-106 MES-17-107 MES-17-108 MES-17-109 MES-17-110 MES-17-111

MES-17-112 MES-17-113 MES-17-114 MES-17-115 MES-17-116 MES-17-117

**MES-17-106 - 117**  
**DE BAKEY**  
 Vascular dilators.  
 malleable  
 190 mm

<b>MES-17-106</b>	0,5 mm Ø	<b>MES-17-112</b>	3,5 mm Ø
<b>MES-17-107</b>	1,0 mm Ø	<b>MES-17-113</b>	4,0 mm Ø
<b>MES-17-108</b>	1,5 mm Ø	<b>MES-17-114</b>	4,5 mm Ø
<b>MES-17-109</b>	2,0 mm Ø	<b>MES-17-115</b>	5,0 mm Ø
<b>MES-17-110</b>	2,5 mm Ø	<b>MES-17-116</b>	7,0 mm Ø
<b>MES-17-111</b>	3,0 mm Ø	<b>MES-17-117</b>	9,0 mm Ø

[Back to index](#)

## Irrigating Cannulae, Embolus Grasping Forceps, Dilators

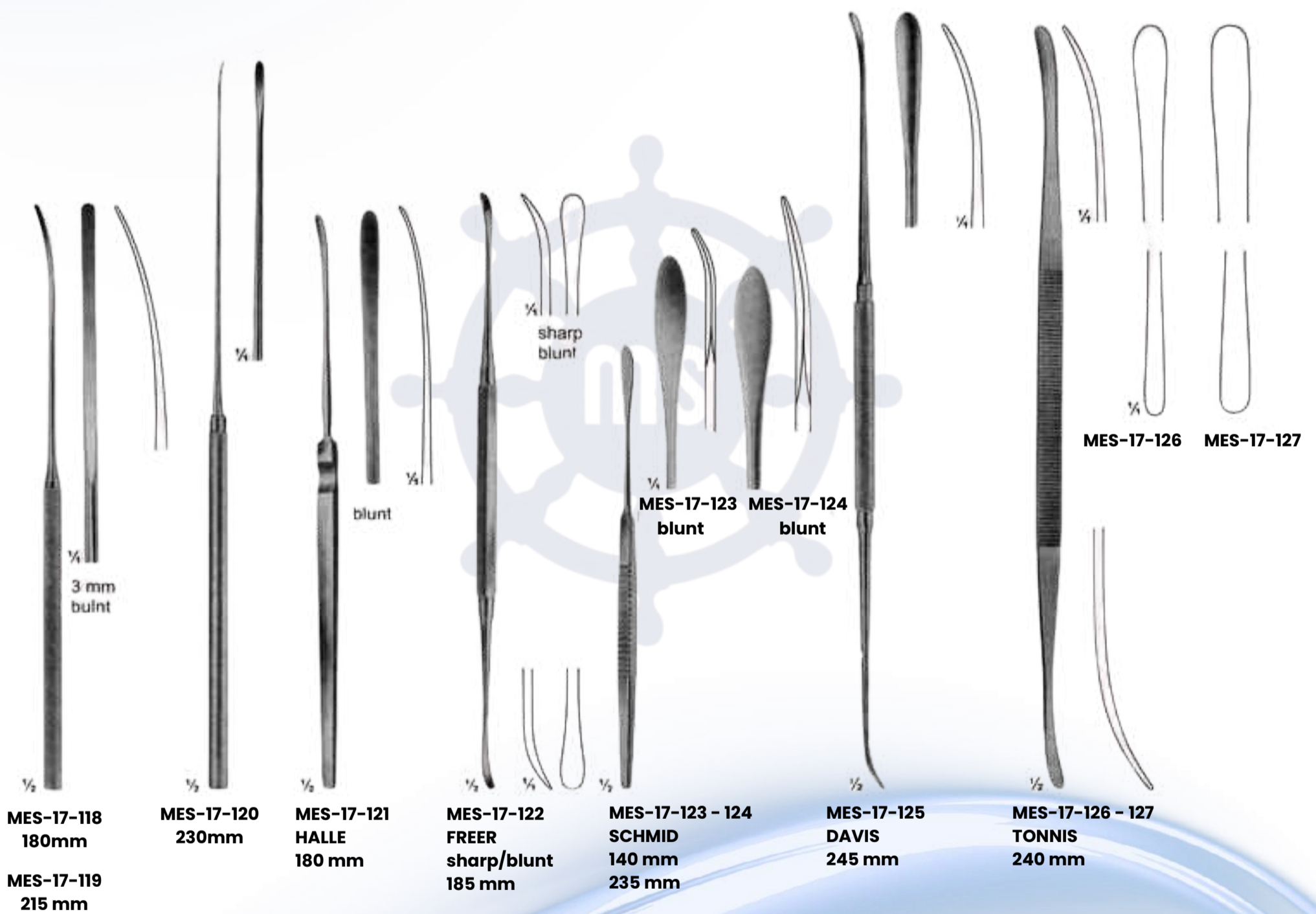

## Irrigating Cannulae, Embolus Grasping Forceps, Dilators

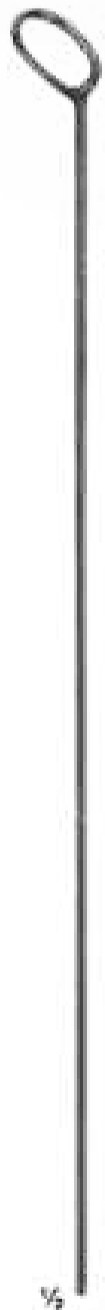
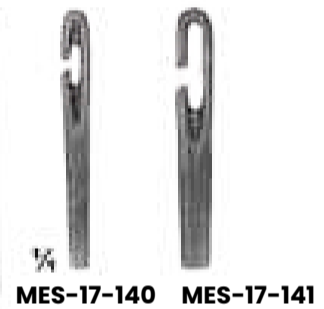
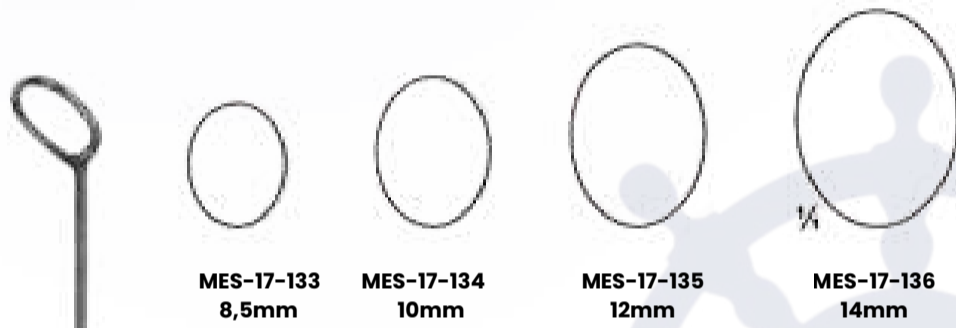
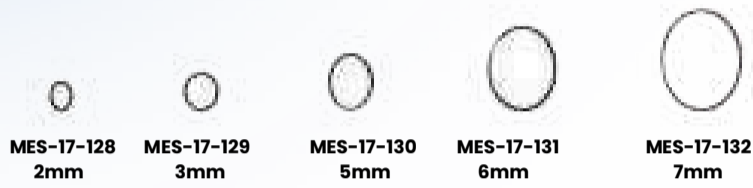

**MES-17-128 - 136**  
**Endarterectomy**  
**strippers**  
**550 mm**

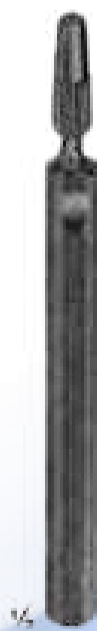

**MES-17-137**  
**Handle for 110 mm**



**MES-17-138 - 139**  
**RUMEL-BELBONT**  
**325 mm**

**MES-17-138 - 4,0 mm**  
**MES-17-139 - 6,4 mm**



**MES-17-140 - 141**  
**Guide only**

## Biopotome and Aortic Dilators



**MES-17-142  
 SCHULZ**  
 Biopotome, mit flexiblen Schaft,  
 510 mm lang. with round jaws  
 3mm diam.

Biopsy forceps, for biopsy from  
 the right atrium through cava  
 jugularis, prior to heart  
 implantations

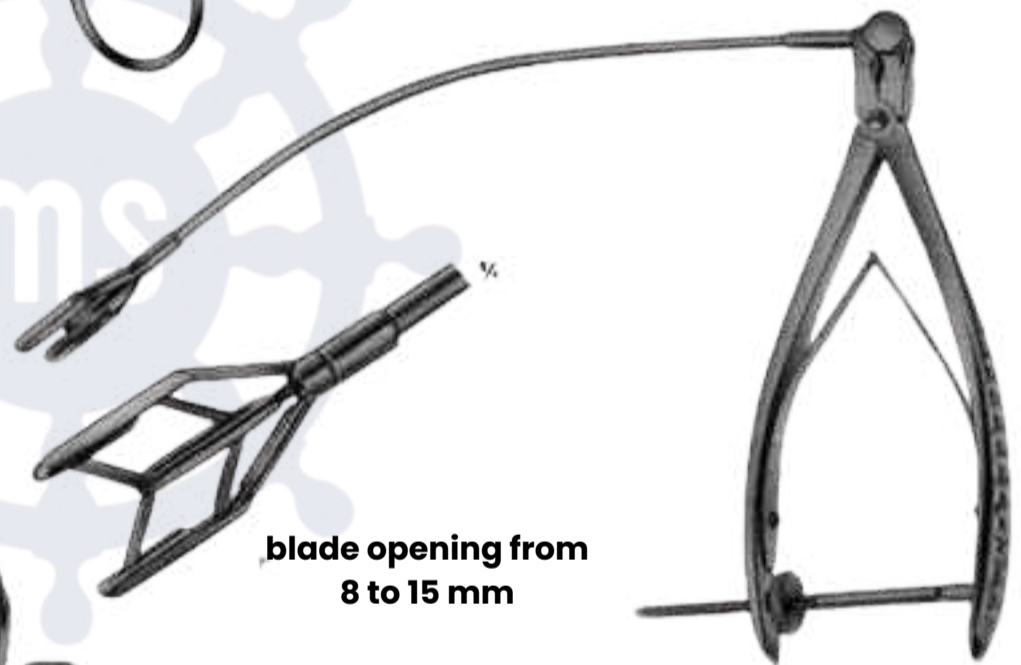

blade opening from  
 8 to 15 mm

**MES-17-144  
 COOLEY**  
 Dilator for mitral  
 valve for children

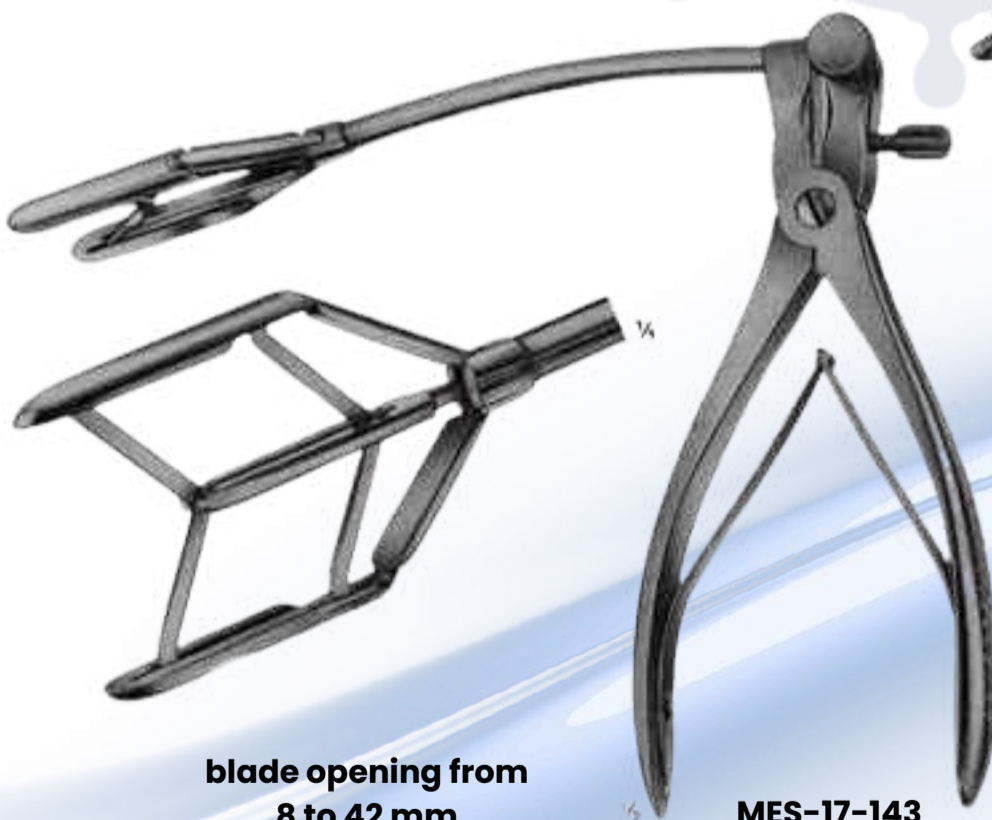

blade opening from  
 8 to 42 mm

**MES-17-143  
 TUBBS**  
 Dilator for  
 mitral valve

## Biopotome and Aortic Dilators

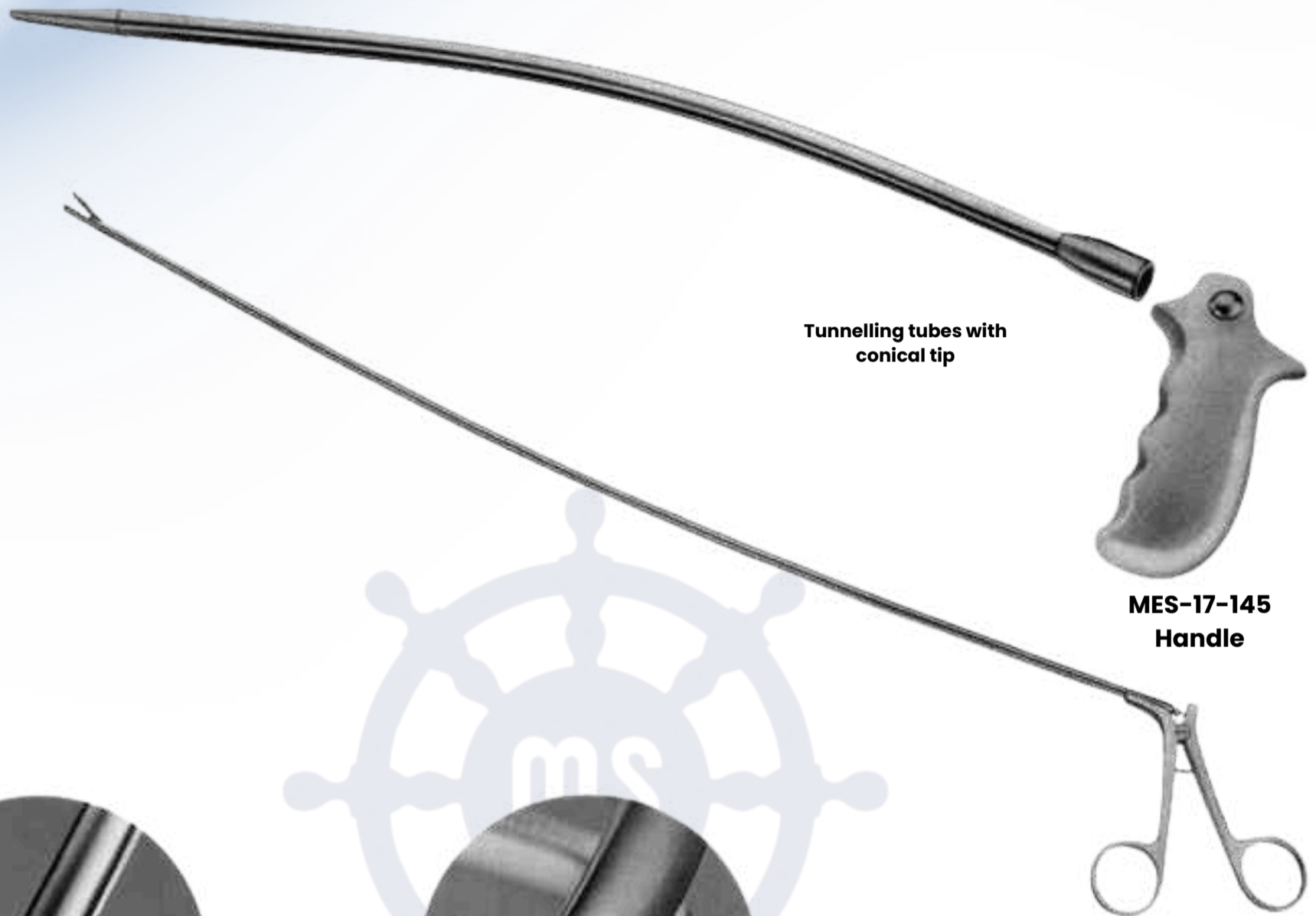

Tunnelling tubes with conical tip

MES-17-145  
Handle

MES-17-146  
Forceps



**DE BAKEY**  
**MES-17-147**  
 1:2 rows of teeth



**DE BAKEY**  
**MES-17-148**  
 2:3 rows of teeth

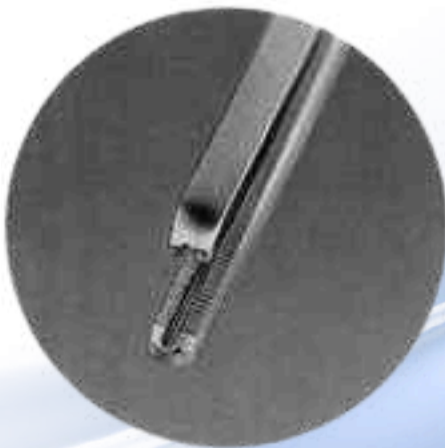
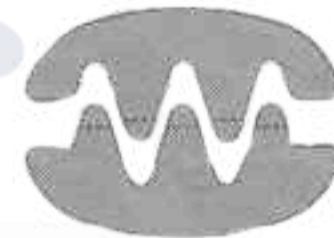

**COOLEY**  
**MES-17-149**  
 2: 2 rows of teeth



**DARDIK**  
**MES-17-150**  
 2: 3 rows of teeth



[Back to index](#)

## Combined Suction and Irrigation Cannulae



**MES-25-178**  
**FINSTERER**  
**320 mm**



**MES-25-179**  
**YASARGIL**  
**LURE-LOCK cone**  
**200 mm**

**MES-25-180**  
**with finger cut-off and styiet,**

**MES-25-181-183**  
**HOUSE**

	suction tube diam.	Irrigation tube Diam.
MES-25-181	0,9 mm	0,7 mm
MES-25-182	1,2 mm	0,9 mm
MES-25-183	1,5 mm	1.2 mm

with linger cut-off and styiet. with LURE hub

**MES-25-184**  
**3,5 mm**  
**with LURE-LOCK cone**

**MES-25-185**  
**LANDOLT**  
**with finger cut-off and**  
**styiet, can be stenzized**  
**in an autoclave up to 3**  
**bar (143 c)**

Connection for suction hose

4 mm diam., Untranished contact to be touched by HF-eleatodes

[Back to index](#)