



شركة الخدمات البحرية المحدودة
MARINE SERVICES CO., LTD.



Accessories, Orthodontic & General Instruments

Precision • Quality • Reliability

Accessories, Orthodontic & General Instruments

- Dental Tweezers
- Copper Ring Removing Pliers
- Dental Crown Removers
- Pliers for Orthodontics
- Rubber Dam Clamp Forceps
- Dental Syringes
- Water Syringes

ISO 13485 AND CE

Manufactured & supplied in compliance with international medical standards.

Dental Tweezers



MED-2995
College
15 cm



smooth



MED-2996
College
15 cm



serrated



MED-2997
College
15 cm



smooth



MED-2998
College
15 cm



smooth



MED-2999
College
15 cm



serrated



MED-3000
College
15 cm



smooth



MED-3000
College



serrated

[Back to Index](#)

Dental Tweezers

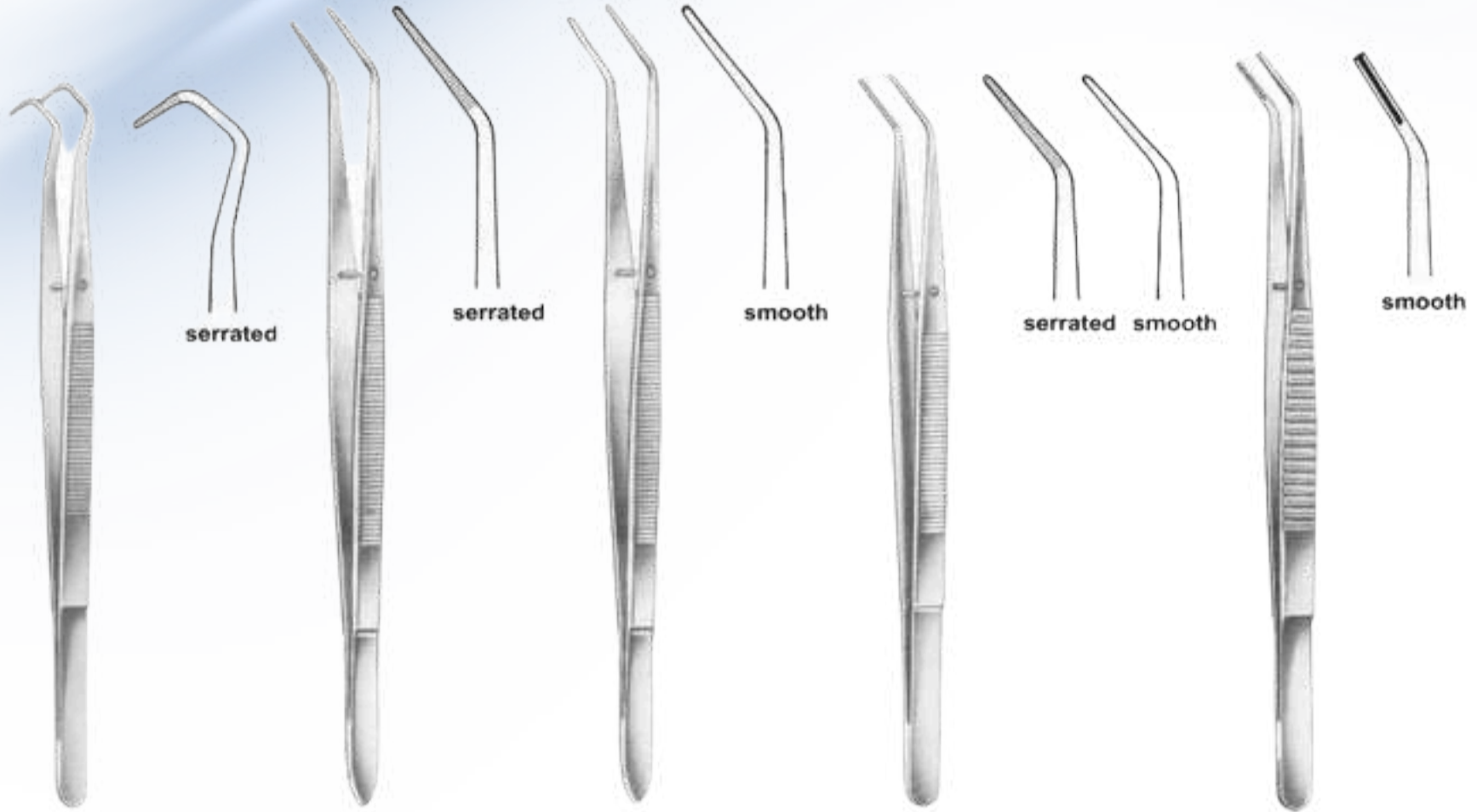

MED-3010
College
14.5 cm, 5 3/4"

MED-3011
Flagg
16 cm, 6 1/4"

MED-3012
Flagg
16 cm, 6 1/4"

MED-3013
Landgraf
15 cm, 6"

MED-3014
15,5 cm, 6 1/8*

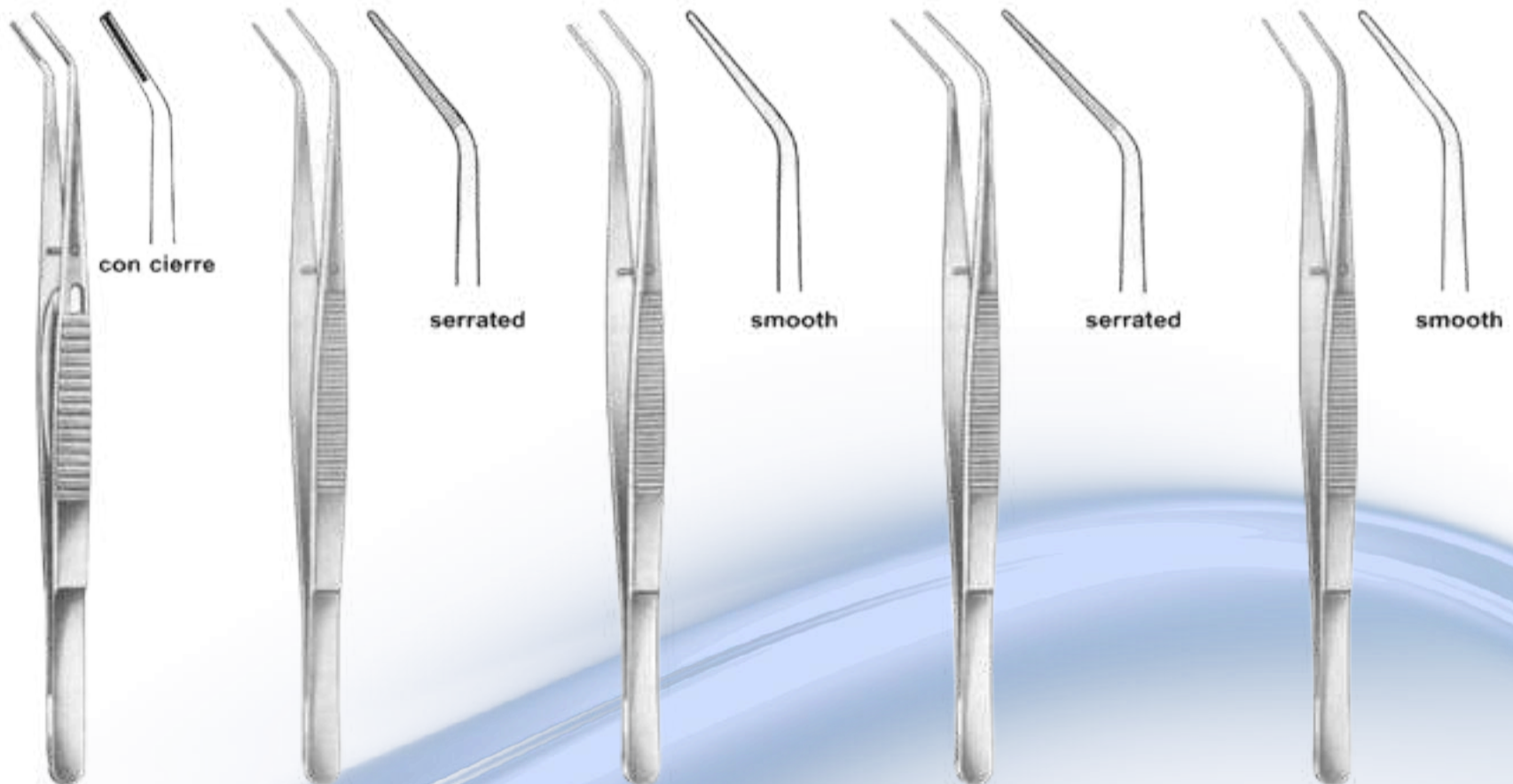

MED-3015
15.5 cm, 6 1/8"

MED-3016
London-College
15 cm. 6"

MED-3017
London-College
15 cm, 6"

MED-3018
London-College
15 cm. 6"

MED-3019
London-College
15 cm. 6"

[Back to Index](#)

Dental Tweezers



MED-3020
CK1
 15 cm, 6"

MED-3021
CK2
 15 cm, 6"

MED-3022
GF2
 16 cm, 6 1/4"

MED-3023
Gf1
 16 cm, 6 1/4"

MED-3024
Kopp
 15.5 cm, 6 1/8"

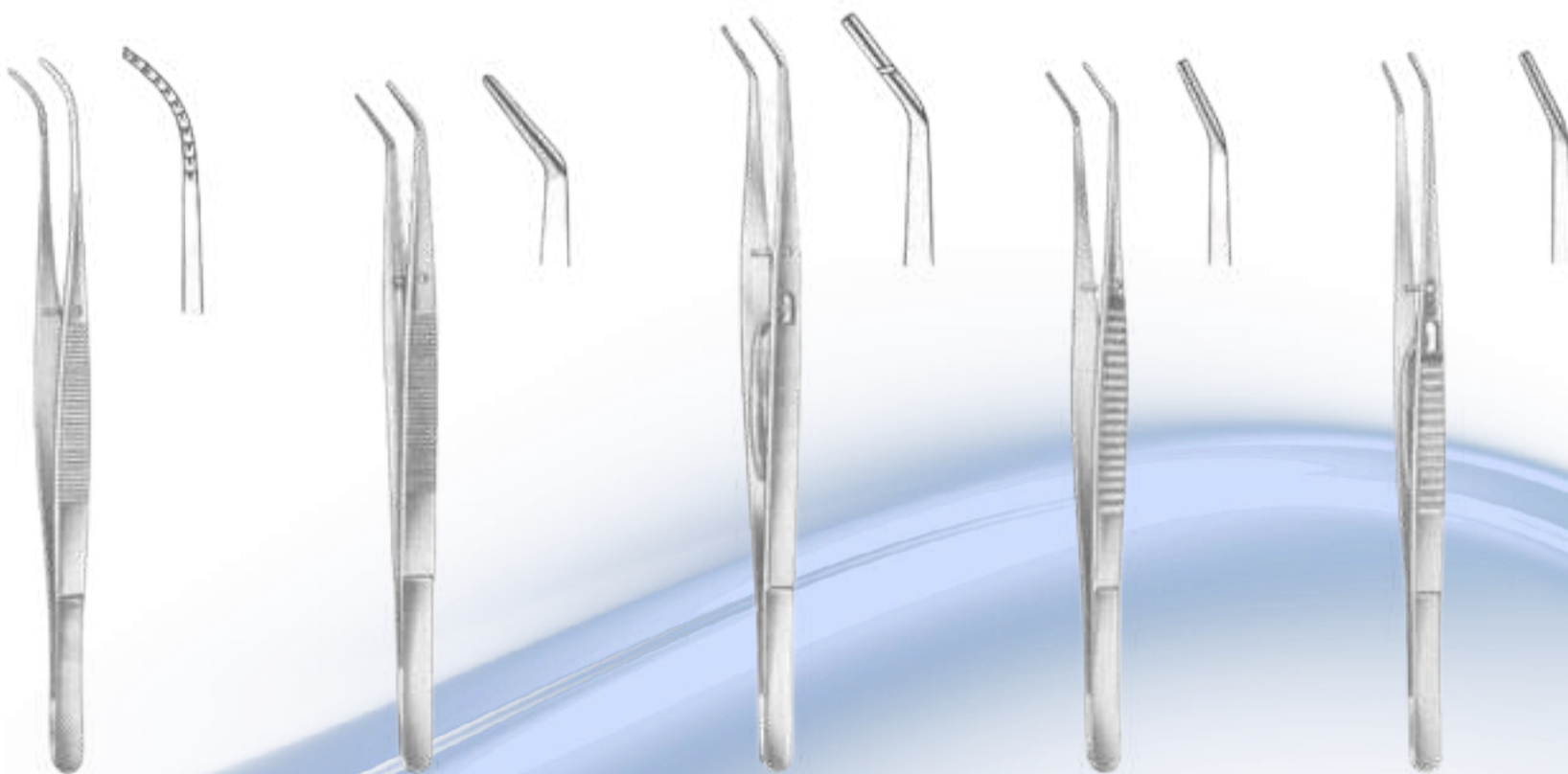

MED-3025
Kopp
 15.5 cm. 6 1/8"

MED-3026
 15 cm, 6"

MED-3027
 16.5 cm, 6 1/2"

MED-3028
 15.5 cm, 6 1/8"

MED-3029
 15.5 cm, 6 1/8"

[Back to Index](#)

Dental Tweezers



MED-3030
London-College
15 cm, 6"



MED-3031
London-College
15 cm, 6"

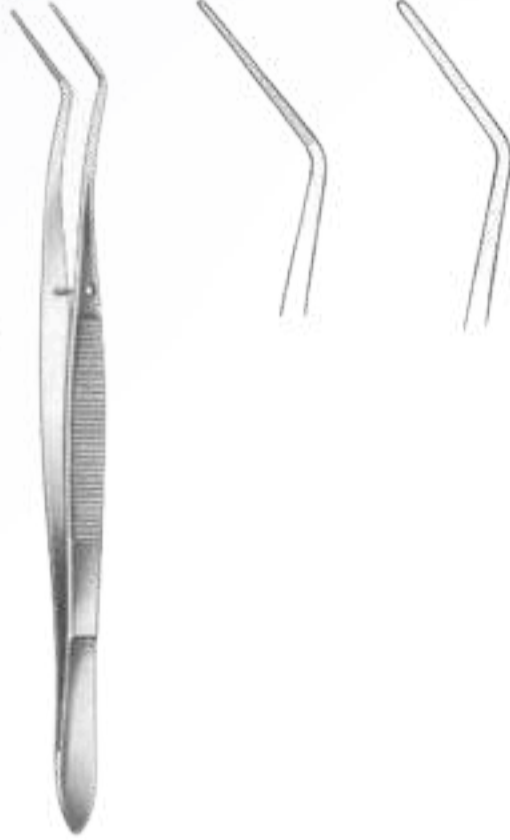

MED-3032
Meriam
16 cm, 6 1/4"

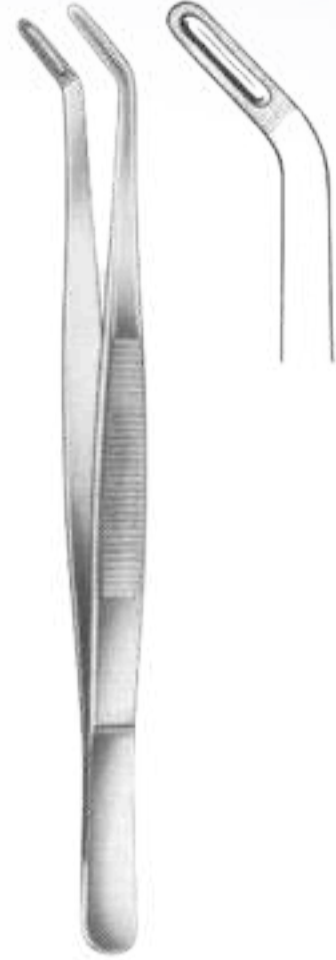

MED-3033
Allen
18 cm, 7 1/8"



MED-3034
Albrecht
16 cm, 6 1/4"



MED-3035
16 cm, 6 1/4"



MED-3036
16 cm, 6 1/4"



MED-3037
16 cm, 6 1/4"

[Back to Index](#)

Copper Ring Removing Pliers, Paper Articulator Forceps



MED-3142
Bohm
 11,5 cm



MED-3143
Bohm
 14,5 cm



MED-3144
Furrer
 16 cm



MED-3145
Furrer
 16 cm



MED-3146
Miller
 15 cm



MED-3147
Miller
 15 cm

ME-3148



MED-3148
Kelly
 14 cm



MED-3149
Halstead-Mosquito
 12 cm



MED-3150
Micro-Mosquito
 10 cm

Dental Crown Removers



Universal "HM"
 12 Cm,434



MED-3119



MED-3120



MED-3121
Beebee
 10,5 cm,41/8*



MED-3122
Mershon



MED-3123
Morell



ME-3124
Morell



ME-3125
Morell



ME-3126
Morell



MED-3127
Treymann



MED-3128
Automatic Crown Remover
With 2 Points



MED-3129



MED-3130

Dental Crown Removers

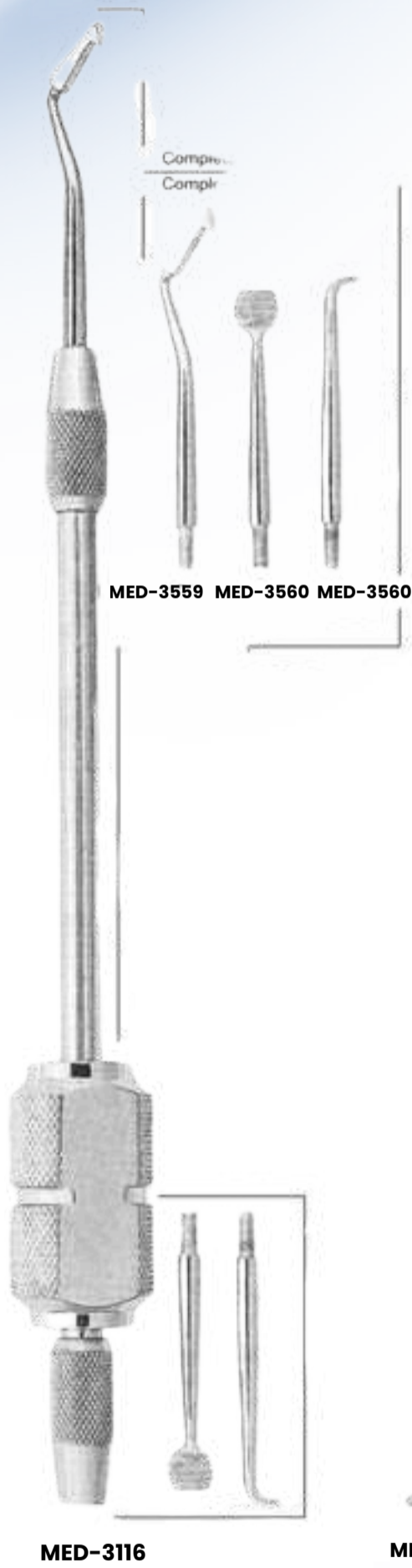

MED-3117
 Crown Spreader, Crown Remove.
 Special instrument for crown spreading after separating. simple and safe operation.

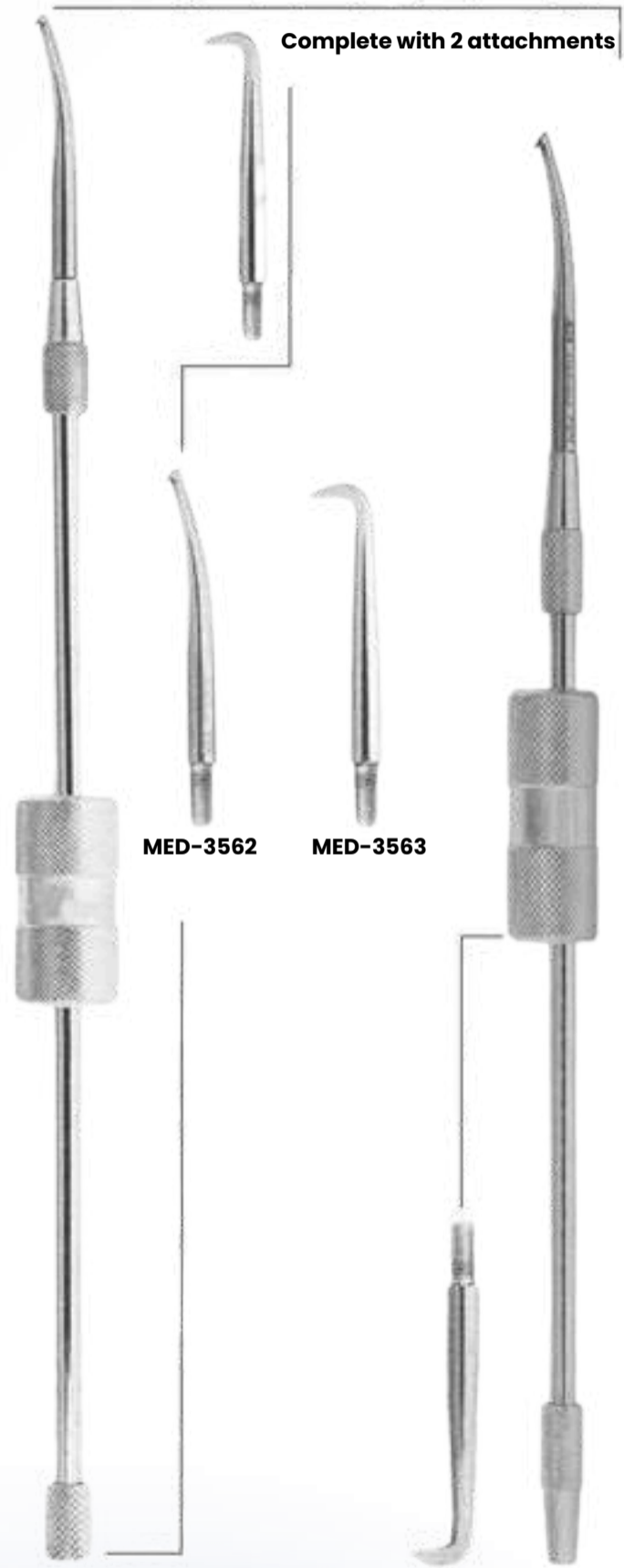

MED-3119

[Back to Index](#)

Pliers for Orthodontics



MED-3193
Adams
 Adams pliers for bending
 wires up to 0,7mm. (.28").



MED-3194
Adams
 Adams pliers for bending
 wires up to 0,7mm. (.28").



MED-3195
Adams
 Tweed loop forming pliers.
 For forming loop in wires up to
 0,56 mm. (.22").



MED-3196
Adams
 Aderer three jaws
 bending pliers. For wires
 up to 0,7 mm. (28").



MED-3197
Adams
 Aderer three jaws bending pliers.
 For wires upto 0,7 mm(28).

Pliers For Orthodontics and Prosthetics



ME-3229
USA Model
125mm

ME-3230
Waldron
125mm

ME-3231
How
140 mm

ME-3232
How
140 mm

ME-3233
Adams
125 mm

ME-3234
Angle
125 mm

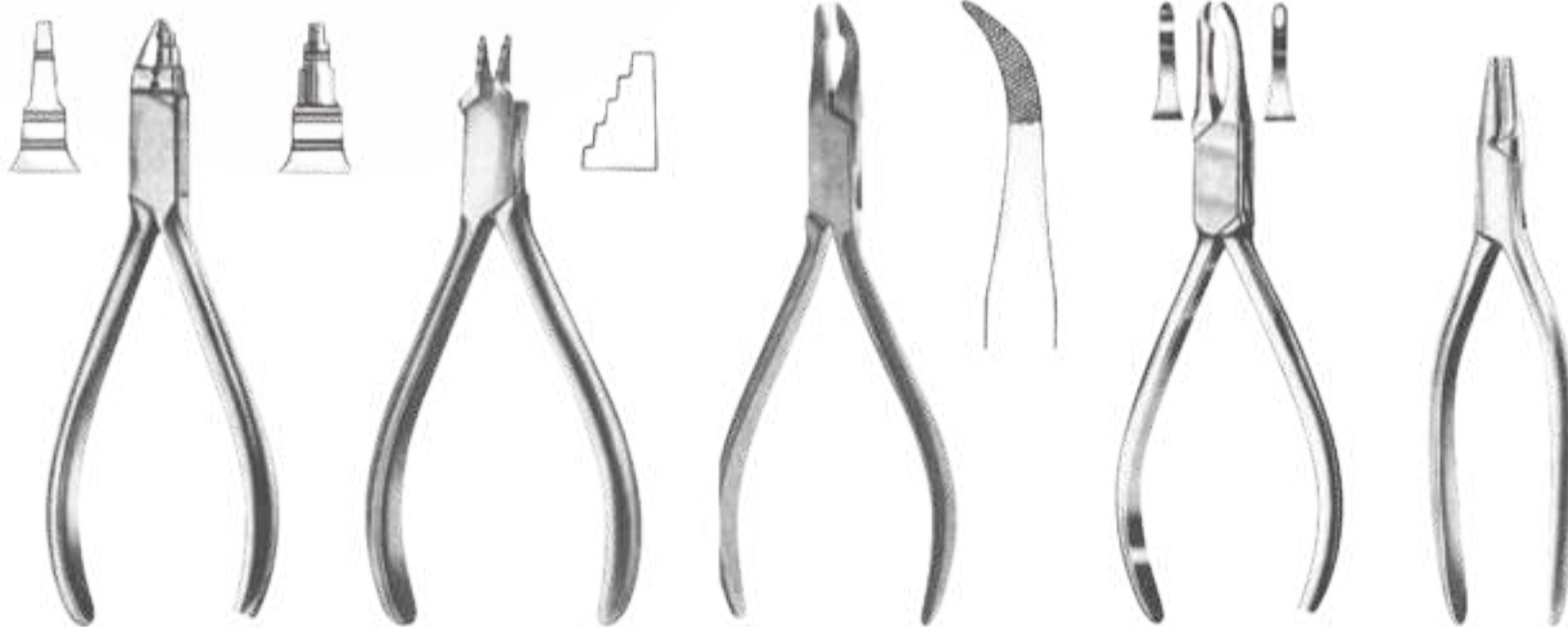

ME-3235
young
130 mm

ME-3236
Nance
130 mm

ME-3237
Weingart
140 mm

ME-3238
Johnson
130 mm

ME-3239
Mc Kellops
155 mm

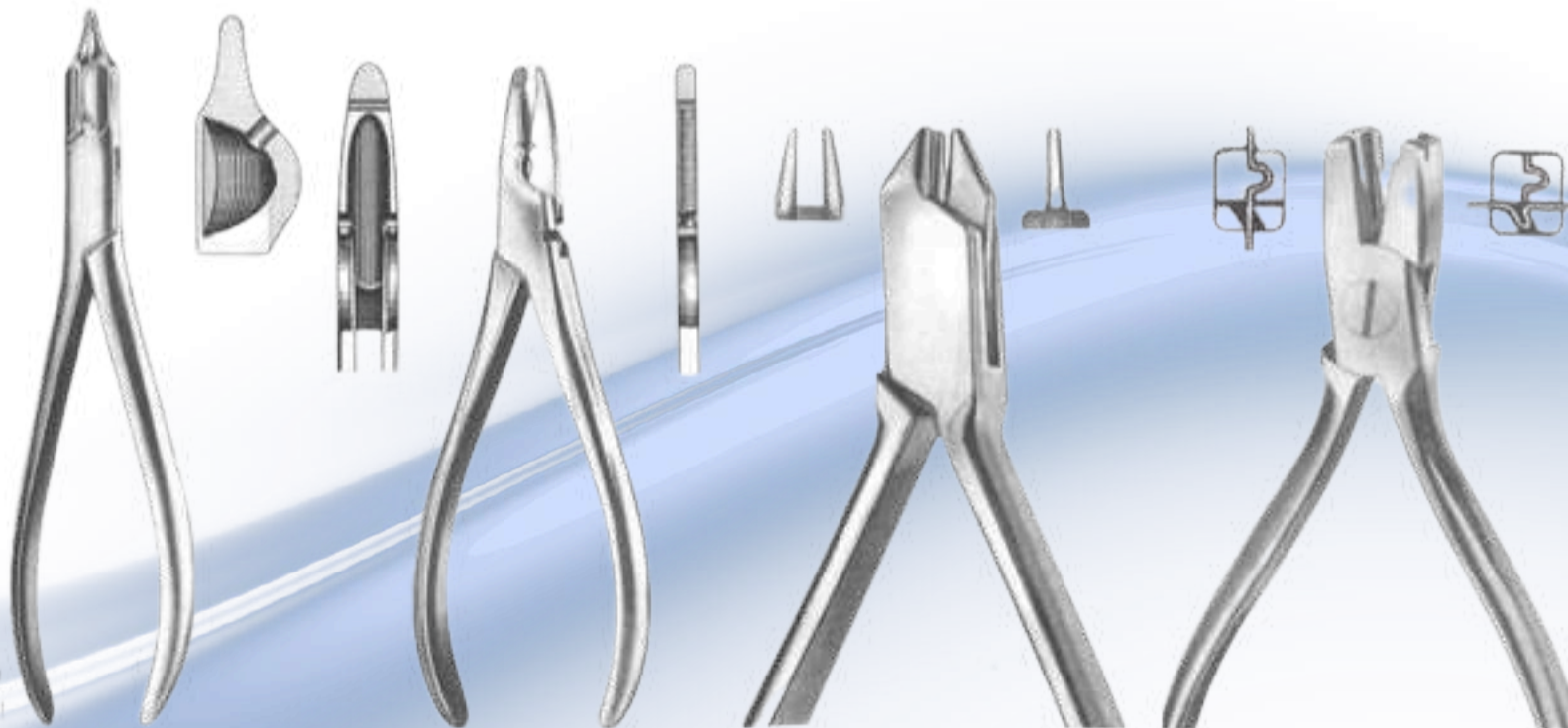

ME-3241
Universal
150 mm

ME-3241
Waldsachs
155 mm

ME-3242
Aderer
125 mm

ME-3243
Nance
130 mm

[Back to Index](#)

Pliers For Orthodontics and Prosthetics



MED-3286
 Langenbeck
 140 mm



MED-3287
 Langenbeck
 130 mm



MED-3288
 Langenbeck
 130 mm



MED-3289
 Peeso
 125 mm



MED-3290
 Goslee
 125 mm



MED-3291
 Fischer
 140 mm.



MED-3292
 Anderson
 130 mm



MED-3293
 Schwarz
 130 mm



MED-3294
 MSY
 130 mm



MED-3295
 Langenbeck
 125 mm



MED-3297



MED-3526



MED-3527



MED-3528



MED-3529



MED-3530



MED-3531

Pliers For Orthodontics and Prosthetics



MED-3297



MED-3298



MED-3299

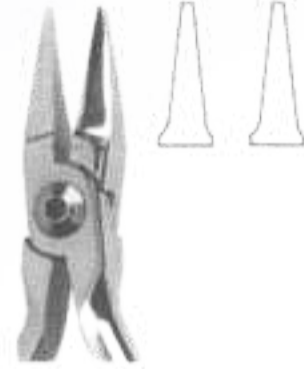

MED-3300



MED-3301



MED-3302



MED-3303



MED-3304



MED-3305



MED-3306



MED-3308



MED-3309



MED-3310



MED-3311



MED-3312



MED-3313



MED-3314



MED-3315

[Back to Index](#)

Rubber Dam Clamp Forceps

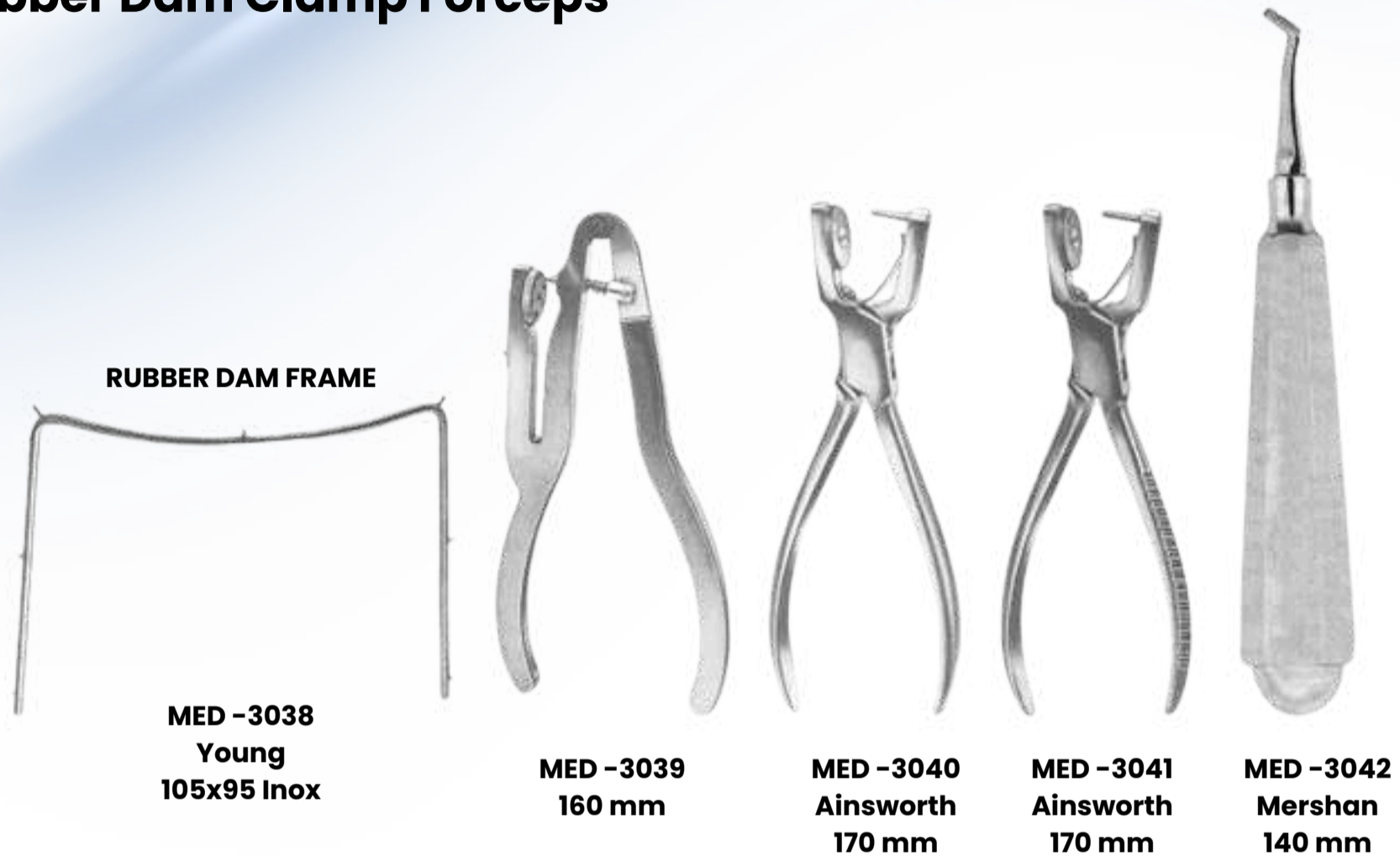

CLAMPS (PLIERS)

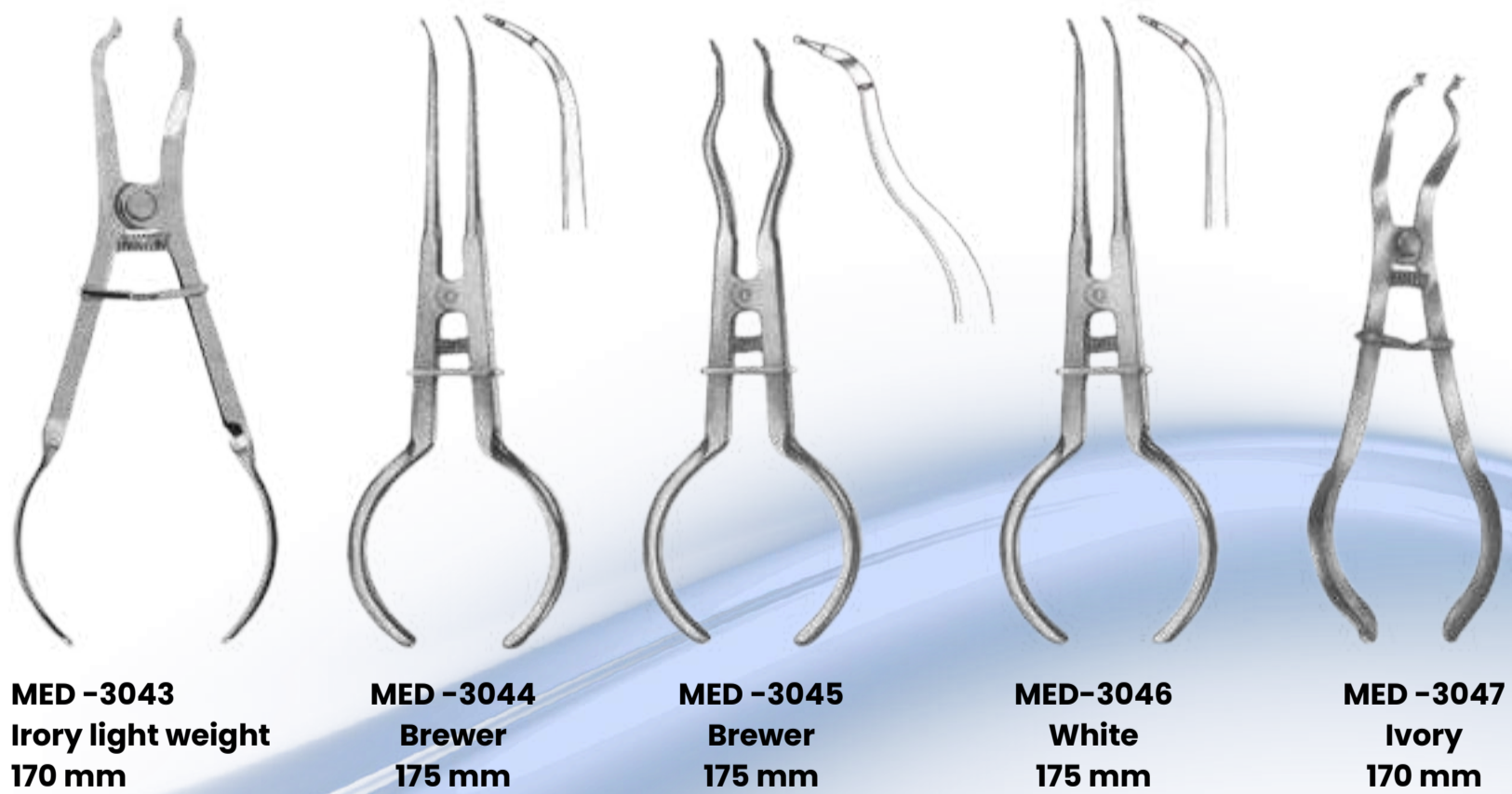

[Back to Index](#)

Rubber Dam Clamp



MED -3048
Winged
Labial Clamp



MED -3049
Winged
Edged Labial Clamp



MED-3050
Winged
Cervical Clamp



MED -3051
Winged
Labial Clamp



MED -3052
Winged



MED -3053
Winged



MED -3054
Wingless

For Small Teeth, Elongated or With Narrow Collars



MED -3055
Winged



MED -3056
Winged



MED -3057
Wingless

For General Use With Adjustable Jaws According
To Gingival Line Shapes



MED -3058
Winged



MED -3059
Edged, Winged



MED -3060
Wingless

For Premolars, With Elongated Collar



MED -3061
Winged



MED -3062
Edged, Winged



MED -3063
Wingless

For Premolars, With Elongated Collar



MED -3064
Wingless



MED -3065
Wingless

Rubber Dam Clamp



MED -3066
Winged

MED -3067
Wingless

MED -3068
Winged

MED-3069
Wingless

For Small Lower Molars

For Small Lower Molars With Round clamps



MED -3070
Winged

MED -3071
Wingless

MED -3072
Winged

MED -3073
Wingless

For Square Lower Molars

For Round Upper Molars



MED -3074
Winged

MED -3075
Wingless

MED -3076
Winged

MED -3077
Wingless

For Molar Roots

For Partially Broken Molars



MED -3078
Winged

MED -3079
Edged Winged

MED -3080
Wingless

MED -3081
Winged

MED -3082
Wingless

For Round Molars, Partially Broken, Undersized or Inclined



MED -3083
Wingless

MED -3084
Wingless

MED -3085
Winged

MED -3086
Winged

[Back to Index](#)

Dental Syringes



ME-2977



MED-2978



MED-2979

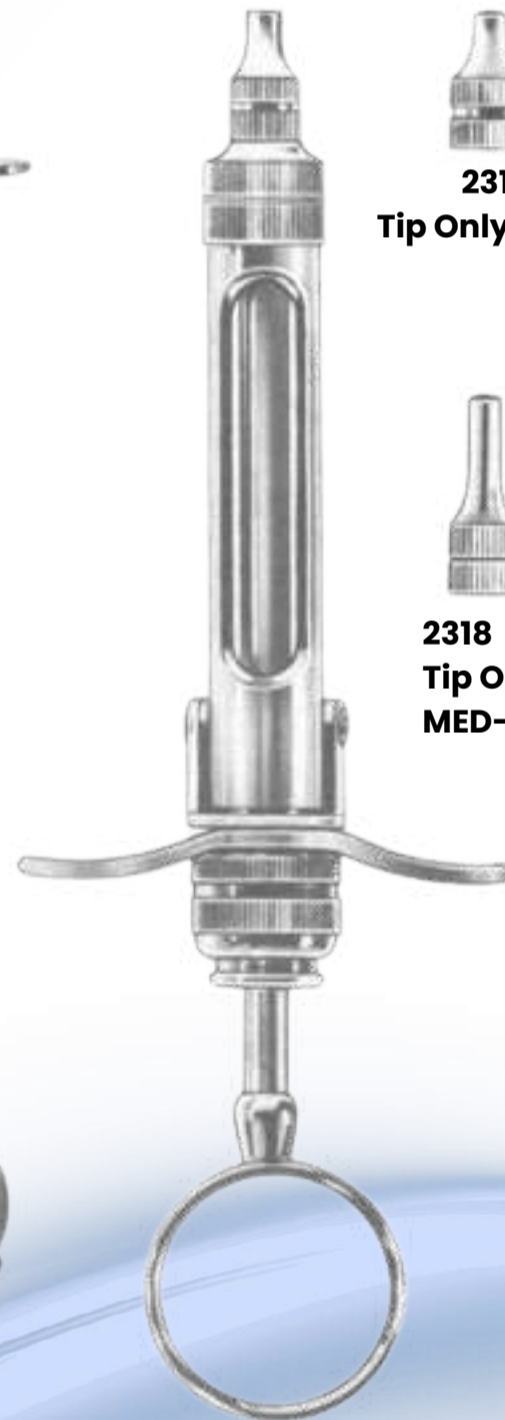

MED-2984 1,8 ml
2,2 ml
Cartridge Syringe complete
With 2 tips and without needles



MED 2982



MED-2983



MED-2985

[Back to Index](#)

Intra-Ligamental Syringes & Dental Syringes



MED-2985
Cork screw tip



MED-2986
Cork screw tip



MED-2987
Folding type, cork
screw tip



MED-2988
Folding type, cork
screw tip



MED-2989



MED-2995
Cork screw tip

MED-2991
Spare cap
with metric
thread

MED-2992
With
Whitworth
thread



MED-2990
Autoclavable Plastic Protection sleeve



MED-2993
Brass syringe with stainless steel moving parts

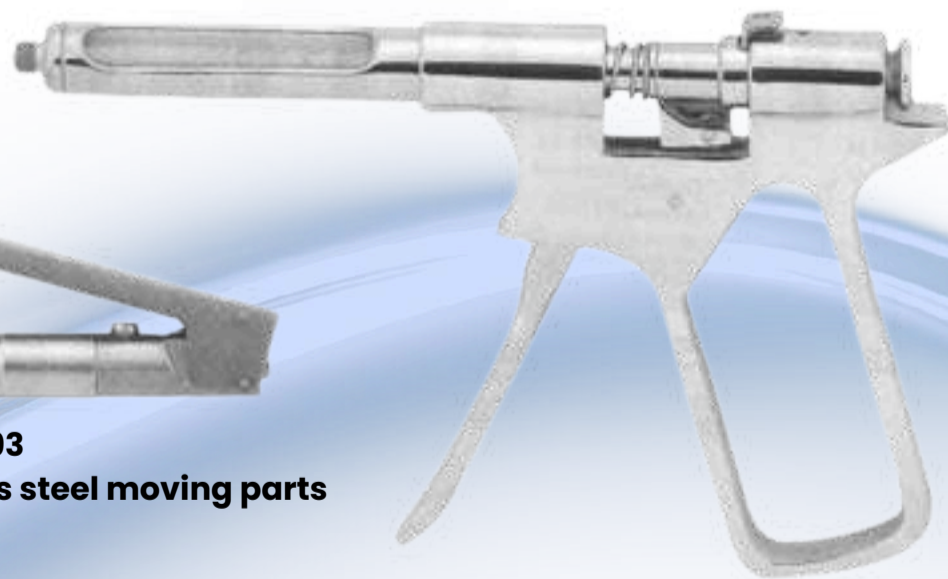

MED-2994
Brass syringe with stainless steel moving parts

[Back to Index](#)

Water Syringes

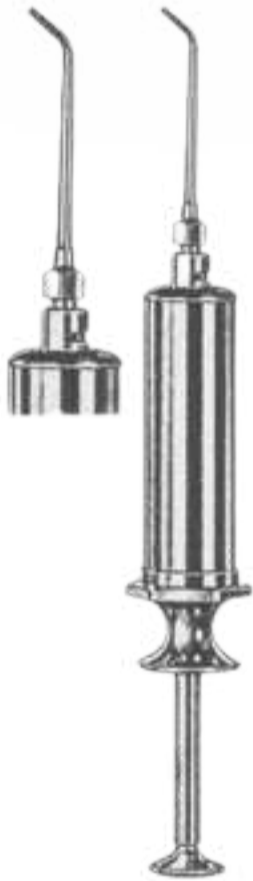

MED -2965
Water Syringe complete with
1 cannula (Lure-Lock)



MED -2966
Water Syringe
complete with 1
cannula (Lure-Lock)



MED -2967
Metal water syringe,
self-filling. with 1
cannula (Lure-Lock)



MED -2968
Sparrel Barrel with
plunger suitable for
syringes



MED -2969
Cannula, only, with
Luer-Lock connector
suitable for syringes